

READ AND SAVE THESE INSTRUCTIONS

OPERATION MANUAL

Adiabatic humidification system
Condair DL

Thank you for choosing Condair

Installation date (MM/DD/YYYY):

Commissioning date (MM/DD/YYYY):

Site:

Model:

Serial number:

Fill in data at the commissioning!

Proprietary Notice

This document and the information disclosed herein are proprietary data of Condair Group AG. Neither this document, nor the information contained herein shall be reproduced, used, or disclosed to others without the written authorisation of Condair Group AG, except to the extent required for installation or maintenance of recipient's equipment.

Liability Notice

Condair Group AG does not accept any liability due to incorrect installation or operation of the equipment or due to the use of parts/components/equipment that are not authorised by Condair Group AG.

Copyright Notice

© Condair Group AG, All rights reserved.

Misapprehension and Technical modifications reserved.

Contents

1	Introduction	5
1.1	To the very beginning	5
1.2	Notes on the operation manual	5
2	For your safety	7
3	Product Overview	9
3.1	Models overview	9
3.2	Product designation / Which model do you have	9
3.3	Basic design the adiabatic air humidification system Condair DL	10
3.4	Functional description	11
3.5	Hydraulic diagram	13
3.6	System overview Condair DL	14
3.7	Overview humidification unit Condair DL	15
3.8	Overview control unit Condair DL	16
3.9	Overview central unit Condair DL	17
4	Operation	18
4.1	First-time commissioning	18
4.2	Display and operating elements	19
4.3	Recommissioning after interruption of operation	20
4.4	Notes on operation	21
4.4.1	Important notes on operation	21
4.4.2	Remote operating and fault indication	21
4.4.3	Inspections during operation	21
4.4.4	Flushing of the internal water system	22
4.4.5	Performing a pressure release of the water system	23
4.4.6	To release the pressure in the water system of the central unit proceed as follows:	23
4.5	Decommissioning the system	24
5	Operating the Condair DL control software	25
5.1	Standard operating display	25
5.1.1	Operating status indication	26
5.1.2	Maintenance and malfunction indications	26
5.2	Navigating/Operating the Condair DL control software	27
5.3	Information functions	28
5.3.1	Accessing support information	28
5.3.2	Accessing system information	28
5.4	Configuration	33
5.4.1	Accessing the "Configuration" submenu	33
5.4.2	Activating/deactivating and configuration of unit functions – "Features" submenu	33
5.4.3	Humidity control Settings – "Control Settings" submenu	34
5.4.4	Basic settings – "General" submenu	36
5.4.5	Communication settings – "Communication" submenu	37

5.5	Maintenance functions	40
5.5.1	Accessing the "Service" submenu	40
5.5.2	Performing maintenance functions – "Service" submenu	40
5.5.2.1	Input diagnostic functions – "Input Diagnostics" submenu	42
5.5.2.2	Relay diagnostic functions – "Relay Diagnostics" submenu	44
5.6	Administration settings	45
5.6.1	Accessing "Administrator" submenu	45
5.6.2	Switching on/off password protection and software updates function - submenu "Administrator"	45
6	Maintenance and Replacement of components	47
6.1	Important notes on maintenance	47
6.2	Hygiene and Maintenance according to VDI 6022 Page 1	48
6.2.1	Periodical checking	48
6.2.2	Total system service	49
6.3	Notes on cleaning and cleaning agents	51
6.4	Removal and installation of components	52
6.4.1	Removal and installation of the ceramic plates	52
6.4.2	Removal and installation of the spray nozzles	54
6.4.3	Removal and installation of the nozzle support	55
6.5	Replacement of the silver ionisation cartridge "Hygieneplus"	56
6.6	Replacement of the optional sterile filter and de-aeration of the filter housing	57
6.7	Resetting the maintenance counter	58
6.8	Performing software updates	59
7	Fault elimination	60
7.1	Important notes on fault elimination	60
7.2	Fault indication	61
7.3	Malfunction list	62
7.4	Malfunctions without indication	68
7.5	Saving fault and service histories to a USB memory stick	69
7.6	Resetting the fault indication	69
7.7	Replacing the fuses and backup battery in the control unit	70
8	Taking out of service/Disposal	71
8.1	Taking out of service	71
8.2	Disposal/Recycling	71
9	Product specification	72
9.1	Technical data	72
9.2	Options	74
10	Appendix	75
10.1	CE declaration of conformity	75
10.2	Wiring diagram Condair DL	76
10.3	Wiring plan Condair DL	77

1 Introduction

1.1 To the very beginning

We thank you for having purchased the **adiabatic air humidification system Condair DL**.

The adiabatic air humidification system Condair DL incorporates the latest technical advances and meets all recognized safety standards. Nevertheless, improper use of the adiabatic air humidification system Condair DL may result in danger to the user or third parties and/or impairment of material assets.

To ensure a safe, proper, and economical operation of the adiabatic air humidification system Condair DL, please observe and comply with all information and safety instructions contained in the present documentation as well as in the separate documentations of the components installed in the humidification system.

If you have questions after reading this documentation, please contact your Condair representative. They will be glad to assist you.

1.2 Notes on the operation manual

Limitation

The subject of this operation manual is the adiabatic air humidification system Condair DL. The various options and accessories are only described insofar as this is necessary for proper operation of the equipment. Further information on options and accessories can be obtained in the respective instructions.

This operation manual is restricted to the **commissioning, operation, maintenance and troubleshooting** of the adiabatic humidification system Condair DL and is meant for **well trained personnel being sufficiently qualified for their respective work**.

This operation manual is supplemented by various separate items of documentation (operation manual, spare parts list, etc.), which are included in the delivery as well. Where necessary, appropriate cross-references are made to these publications in the operation manual.

Symbols used in this manual



CAUTION!

The catchword "CAUTION" used in conjunction with the caution symbol in the circle designates notes in this operation manual that, if neglected, may cause **damage and/or malfunction of the unit or other material assets**.



WARNING!

The catchword "WARNING" used in conjunction with the general caution symbol designates safety and danger notes in this operation manual that, if neglected, may cause to **injury to persons**.



DANGER!

The catchword "DANGER" used in conjunction with the general caution symbol designates safety and danger notes in this operation manual that, if neglected, may lead to **severe injury or even death of persons**.

Safekeeping

Please safeguard this operation manual in a safe place, where they can be immediately accessed. If the equipment changes hands, the documentation must be passed on to the new operator.

If the documentation gets mislaid, please contact your Condair representative.

Language versions

This operation manual is available in various languages. Please contact your Condair representative for information.

2 For your safety

General

Every person working with the adiabatic air humidification system Condair DL must have read and understood the installation manual and the operation manual of the Condair DL before carrying out any work. Knowing and understanding the contents of the installation manual and the operation manual is a basic requirement for protecting the personnel against any kind of danger, to prevent faulty operation, and to operate the unit safely and correctly.

All ideograms, signs and markings applied to the components of the adiabatic humidification system Condair DL must be observed and kept in readable state.

Qualification of personnel

All work described in this operation manual **may only be carried out by specialist who are well trained and adequately qualified and are authorized by the customer.**

For safety and warranty reasons any action beyond the scope of this manual must be carried out only by qualified personnel authorised by the manufacturer.

It is assumed that all persons working with the adiabatic humidification system Condair DL are familiar and comply with the appropriate regulations on work safety and the prevention of accidents.

The adiabatic humidification system Condair DL may not be used by persons (including children) with reduced physical, sensory or mental abilities or persons with lacking experience and/or knowledge, unless they are supervised by a person responsible for their safety or they received instructions on how to operate the system.

Children must be supervised to make sure that they do not play with the adiabatic humidification system Condair DL.

Intended use

The adiabatic humidification system Condair DL is intended exclusively for **air humidification in AHU's or air ducts** within the specified operating conditions (see [chapter 9.1](#)). Any other type of application, without the written consent of the manufacturer, is considered as not conforming with the intended purpose and may lead to the adiabatic humidification system Condair DL becoming dangerous.

Operation of the equipment in the intended manner requires **that all the information contained in this operation manual are observed (in particular the safety instructions).**

Danger that may arise from the adiabatic humidification system Condair DL



DANGER!
Risk of electric shock!

The control unit of the Condair DL and the pump inside the central unit (if applicable) are mains powered. Live parts may be exposed when the control unit and/or the central unit is/are open. Touching live parts may cause severe injury or danger to life.

Prevention: Before carrying out any work on the components of the Condair DL take the system out of operation as described in [chapter 4.5](#) and secure the system against inadvertent power-up.

Important: the frequency converter in the control unit of Type A systems with booster pump contains condensers, which under certain circumstances may remain loaded with a potentially deadly voltage for a certain amount of time, after the control unit has been separated from the mains. If work has to be carried out on the frequency converter and/or the booster pump wait at least 10 minutes after the control unit has been separated from the mains and make sure the appropriate contacts on the frequency converter and the terminals on the booster pump are free of voltage before starting any work on these components.



DANGER!
Health risk because of inadequate hygiene!

Inadequately operated and/or poorly maintained adiabatic humidification systems may endanger the health. When inadequately operated and/or poorly maintained micro-organisms (including the bacterium which causes Legionnaire's disease) may grow in the water system and in the area of the humidification unit and may affect the air in the AHU/air duct.

Prevention: the adiabatic humidification system Condair DL must strictly be operated and maintained in accordance with this manual.

Behaviour in case of danger

If it is suspected that **safe operation is no longer possible**, then the adiabatic air humidification system Condair DL should immediately **be shut down and secured against accidental power-up according to [chapter 4.5](#)**. This can be the case under the following circumstances:

- if components of the adiabatic air humidification system Condair DL are not correctly positioned, locked or sealed
- if the adiabatic air humidification system Condair DL is damaged
- if the adiabatic air humidification system Condair DL is no longer operating correctly
- if connections and/or piping are not sealed
- if the electrical installations are damaged

All persons working with the adiabatic air humidification system Condair DL must report any alterations to the system that may affect safety to the owner without delay.

Prohibited modifications to the unit

No modifications must be undertaken on the adiabatic air humidification system Condair DL without the express written consent of the manufacturer.

For the replacement of defective components use exclusively **original accessories and spare parts** available from your Condair representative.

3 Product Overview

3.1 Models overview

The adiabatic air humidification system Condair DL is available in two base models (Type A: with booster pump, Type B: without booster pump) for different duct/AHU sizes.

	Condair DL .	
	Type A (with booster pump)	Type B (without booster pump)
Duct inside width "W" [mm]	450 ... 8400 **	
Duct inside height "H" [mm]	450 ... 4000 **	
Humidification capacity [l/h]	5 ... 1000 **	5 ... 1000 **

** Larger systems on request

Both base models can be extended with different options in their functionality. Furthermore, there are different accessories available.

3.2 Product designation / Which model do you have

The product designation and the most important unit data are found on the rating plates fixed on the right side of the control unit and the central unit. Please refer to the Nortec DL installation manual for detailed information regarding the type plate and the product key.

3.3 Basic design the adiabatic air humidification system Condair DL

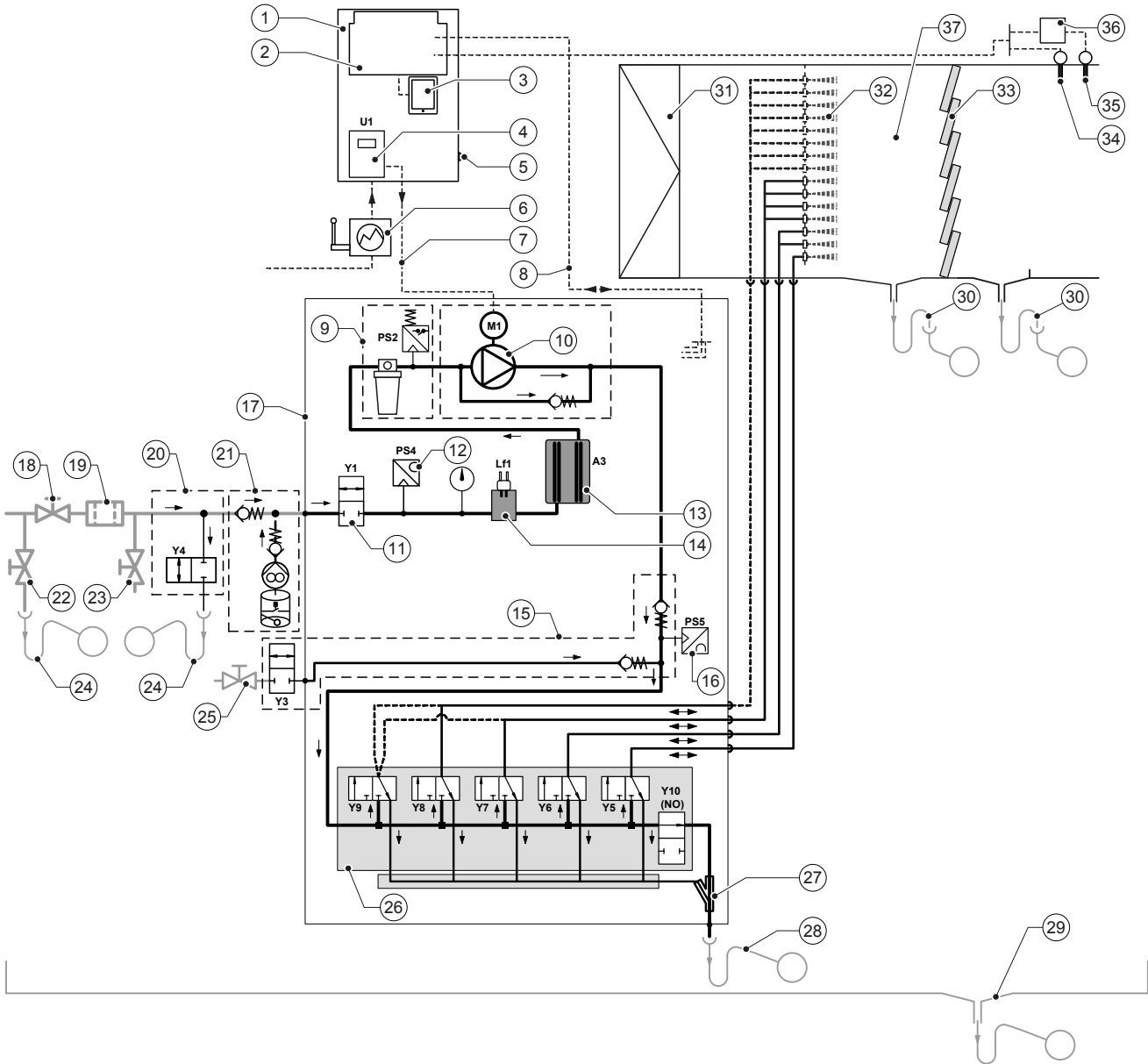

- | | |
|--|---|
| 1 Control unit | 19 External water filter 5µm (recommended, option or by others) |
| 2 Driver board | 20 External pipe flush (option) |
| 3 Control board with touch screen | 21 External disinfection pump with tank (optional, by others) |
| 4 Frequency converter for booster pump (Type A) | 22 Drain valve water supply pipe (by others) |
| 5 Switch <Control unit On/Off> | 23 Test valve, flame treatable (by others) |
| 6 Mains supply via electrical isolator | 24 Funnel with trap (by others) |
| 7 Voltage supply booster pump motor | 25 Shut-off valve pressured air supply (by others) |
| 8 Cable harnesses sensors and valves | 26 Valve manifold with spray nozzles Y5-Y9 and drain valve Y10 |
| 9 Option sterile filter with pressure switch PS2 (Type A) or without pressure switch PS2 (Type B) | 27 Water jet pump (spray circuits drain) |
| 10 Booster pump (Type A) | 28 Drain with trap (by others) |
| 11 Inlet valve Y1 | 29 Water tub or floor drain with trap (by others) |
| 12 Pressure sensor inlet pressure PS4 | 30 Duct/AHU drains with trap (by others) |
| 13 Silver ionisation A3 | 31 Air filter min. F7 or EU7 (by others) |
| 14 Conductivity sensor Lf1 | 32 Spray nozzles |
| 15 Air cleaning (option) | 33 Post-evaporation elements (porous ceramics) |
| 16 Pressure sensor nozzle pressure PS5 (on systems Type B without optional sterile filter not present) | 34 Humidity sensor (by others) |
| 17 Central unit | 35 Temperature- and humidity sensor (by others) |
| 18 Shut-off valve RO water supply (by others) | 36 External continuous controller (by others, e.g. Enthalpy controller) |
| | 37 Air duct/AHU |

Fig. 1: Basic design the adiabatic air humidification system Condair DL

3.4 Functional description

From the reverse-osmosis system (RO system) the fully demineralized water (also called RO water or permeate) is fed via a shut-off valve (18, by others) and an external water filter 5µm (19, recommended, option or by others) to the central unit (17).

In the central unit the RO water is fed via the inlet valve Y1 (11), the conductivity measurement Lf1 (14), and the silver ionization (13) which sterilizes the water and the optional sterile filter (9) to the valve manifold (26) with the spray valves and the drain valve Y10.

On systems type A the central unit is equipped with a booster pump (10) (controlled via the frequency converter) which increases the water pressure to the required operating pressure of approximately 7 bars (yield load) starting from a certain humidity demand.

When a humidity demand is present the spray valves open depending on the demand:

- one or two spray valves (with 2 spray circuits: Y5-Y6),
- one, two or all three spray valves (with 3 spray circuits: Y5-Y7),
- one, two or all four spray valves (with 3 spray circuits with double stage: Y5-Y7+Y9) or
- one, two, three or all four spray valves (with 4 spray circuits: Y5-Y8) or
- one, two, three or all five spray valves (with 4 spray circuits with double stage: Y5-Y8+Y9) or
- one, two, three, four or all five spray valves (with 5 spray circuits: Y5-Y9).
- one, two, three, four or all six spray valves (with 5 spray circuits with double stage: Y5-Y9 + Y9.1).

The fully demineralized water is now fed to the respective spray nozzles (32) producing fine drops. The air passing by the nozzles absorbs the drop thus getting humidified. Drops not absorbed by the air is retained in the post-evaporation elements (33) thus humidifying the air passing through the post-evaporation elements. Excess water flows down to the bottom of the post-evaporation unit and is led via the siphon trap (30) and open funnel to the waste water line of the building.

Control

The system is controlled by an external controller (enthalpy controller recommended) or by the P/PI controller built into the control unit.

On systems:

- with 2 spray circuits a 3-step control is provided,
- with 3 spray circuits (with or without double stage) a 7-step control is provided,
- with 4 spray circuits (with or without double stage) a 15-step control is provided,
- with 5 spray circuits (with or without double stage) a 31-step control is provided

On systems type A the booster pump is switched on at a demand of approx. 60-70 % (switching point is dependent on the inlet pressure), and then the capacity is controlled continuously up to 100% via the pump speed.

Monitoring

The inlet pressure and the nozzle pressure are monitored with the analogue pressure sensors "PS4" and "PS5". On systems type B without booster pump and without optional sterile filter the nozzle pressure is equal to the inlet pressure, thus the pressure sensor "PS5" is not present.

The pressure after the optional sterile filter is monitored with the pressure switch "PS2" on systems type A (with booster), and on systems type B (without booster pump) with the pressure sensor "PS5" since the pressure after the sterile filter is equal to the nozzle pressure.

The conductivity of the fully demineralized water is continuously monitored. If the conductivity of the fully demineralized water exceeds the admissible range (max. 15 $\mu\text{S}/\text{cm}$), the drain valve Y10 on the valve manifold (26) opens and the water system is flushed until the conductivity meets the preset value. A fault message is displayed or the system is stopped if the conductivity value does not reach the admissible range within a certain period (conductivity $>100 \mu\text{S}/\text{cm}$).

Hygiene function/Flushing

In order to prevent standing water, each spray circuit which is not active is emptied via the corresponding spray valve (the spray valves are connected to the drain in currentless status).

If the conductivity in the water supply line exceeds a preset value or if the humidification system has been without demand for more than 23 hours, the drain valve Y10 opens and the water supply line and the water lines in the central unit are flushed for a certain time with fresh RO water. During the flushing additionally residual water in the spray circuits is sucked out via the built in water jet pump (27) and is led via the open funnel with trap (28) to the waste water line of the building.

3.5 Hydraulic diagram

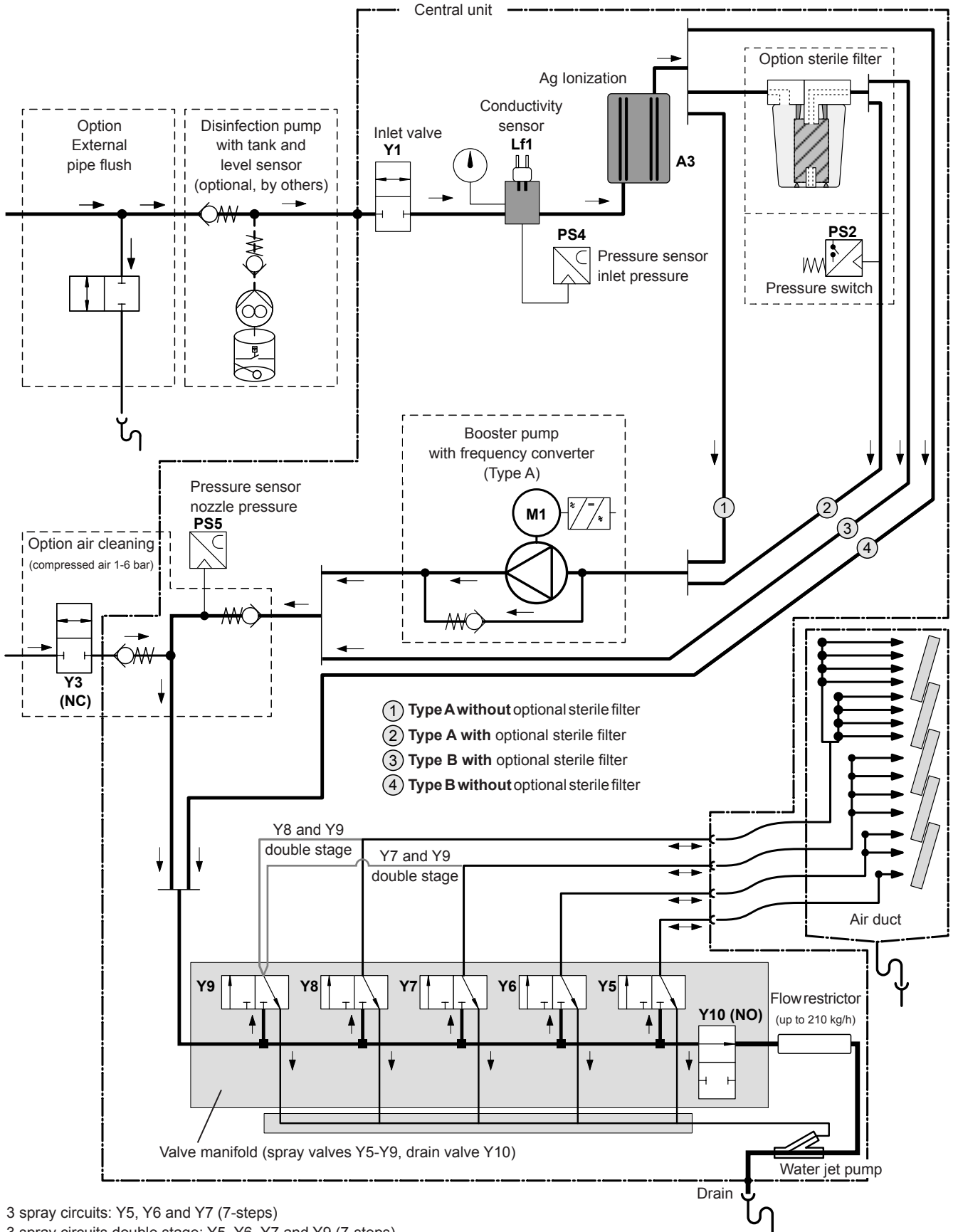

- 3 spray circuits: Y5, Y6 and Y7 (7-steps)
- 3 spray circuits double stage: Y5, Y6, Y7 and Y9 (7-steps)
- 4 spray circuits: Y5, Y6, Y7 and Y8 (15-steps)
- 4 spray circuits with double stage: Y5, Y6, Y7, Y8 and Y9 (15-steps)

Fig. 2: Hydraulic diagram humidification system Condair DL (Figure shows 15 steps control)

3.6 System overview Condair DL

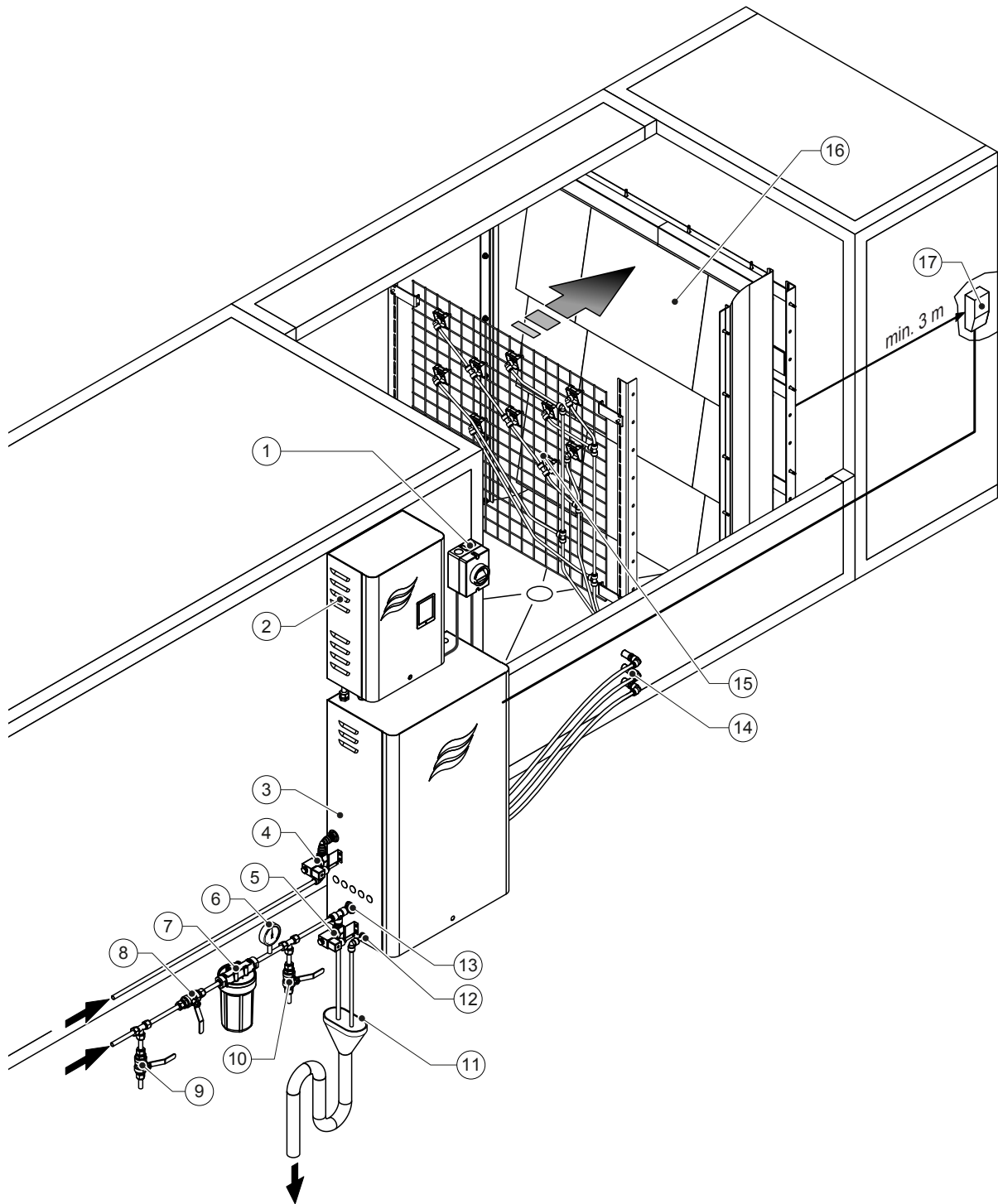

- | | |
|---|--|
| <ul style="list-style-type: none"> 1 Electrical isolator mains supply 2 Control unit 3 Central unit 4 Valve air cleaning (option) 5 Valve external pipe flush (option) - plug-in coupling $\varnothing 12$ mm or 1/2" male thread adapter (supplied) 6 Manometer (recommended, by others) 7 External water filter 5μm (recommended, option or by others) 8 Shut-off valve water supply (mandatory, by others) 9 Drain valve water supply line 10 Test valve, flame treatable (recommended, by others) | <ul style="list-style-type: none"> 11 Open funnel with trap (by others) 12 Water drain connector - plug-in coupling $\varnothing 10$ mm or 1/2" male thread adapter (supplied) 13 Water supply connector - plug-in coupling $\varnothing 12$ mm or 1/2" male thread adapter (supplied) 14 Wall feed throughs spray circuits ($\varnothing 8/10$ mm) 15 Grid with nozzles 16 Post-evaporation unit 17 Humidity controller (e.g. enthalpy controller) or humidity sensor (by others) |
|---|--|

Fig. 3: System overview Condair DL

3.7 Overview humidification unit Condair DL

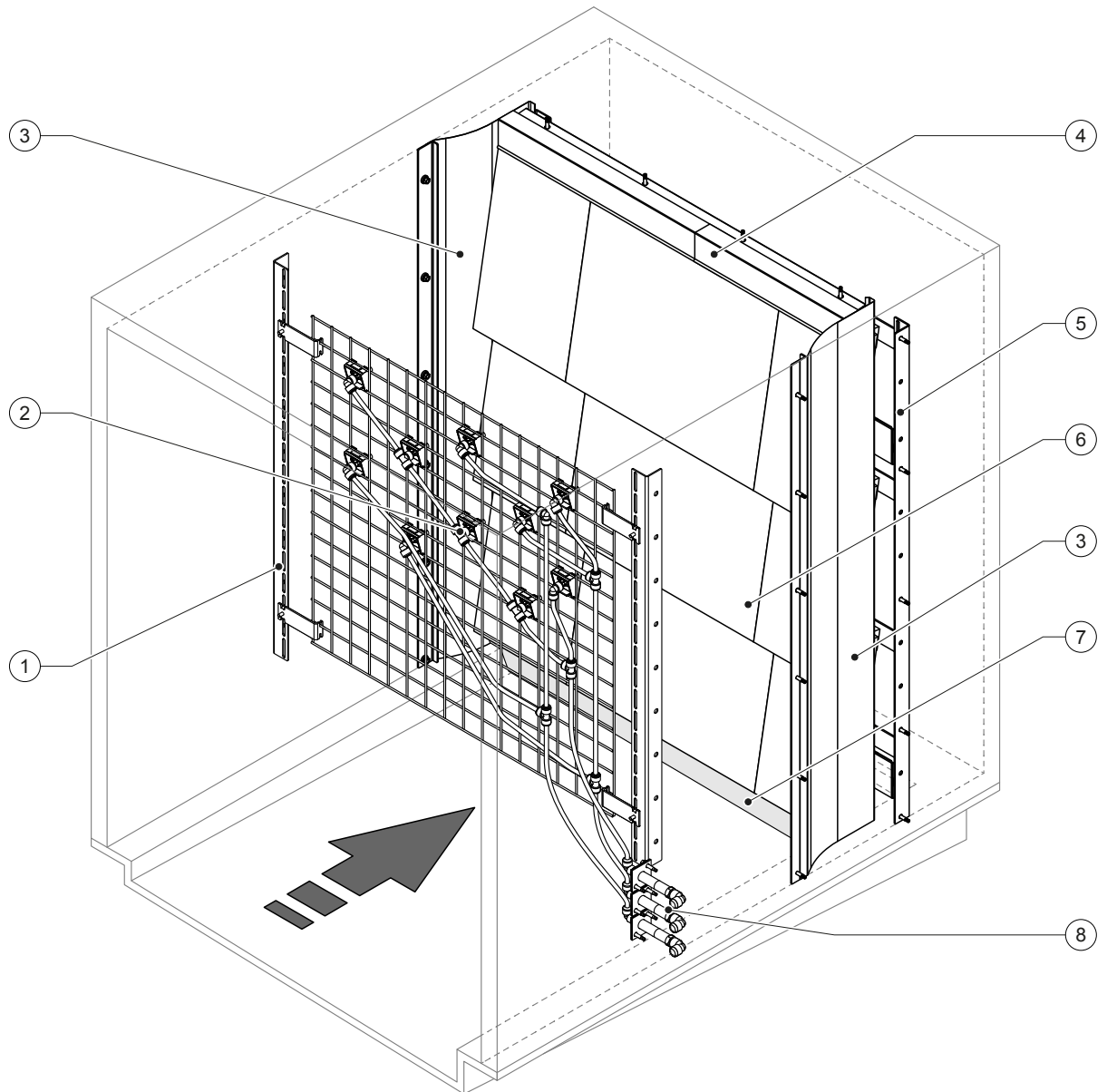

- | | | | |
|---|---------------------------|---|-------------------------------------|
| 1 | Support frame Nozzle unit | 5 | Support frame post-evaporation unit |
| 2 | Spray nozzles | 6 | Ceramic plates |
| 3 | Lateral sealing plates | 7 | Rubber sealing duct floor |
| 4 | Upper sealing plates | 8 | Wall feed throughs spray circuits |

Fig. 4: Overview Humidification unit Condair DL

3.8 Overview control unit Condair DL

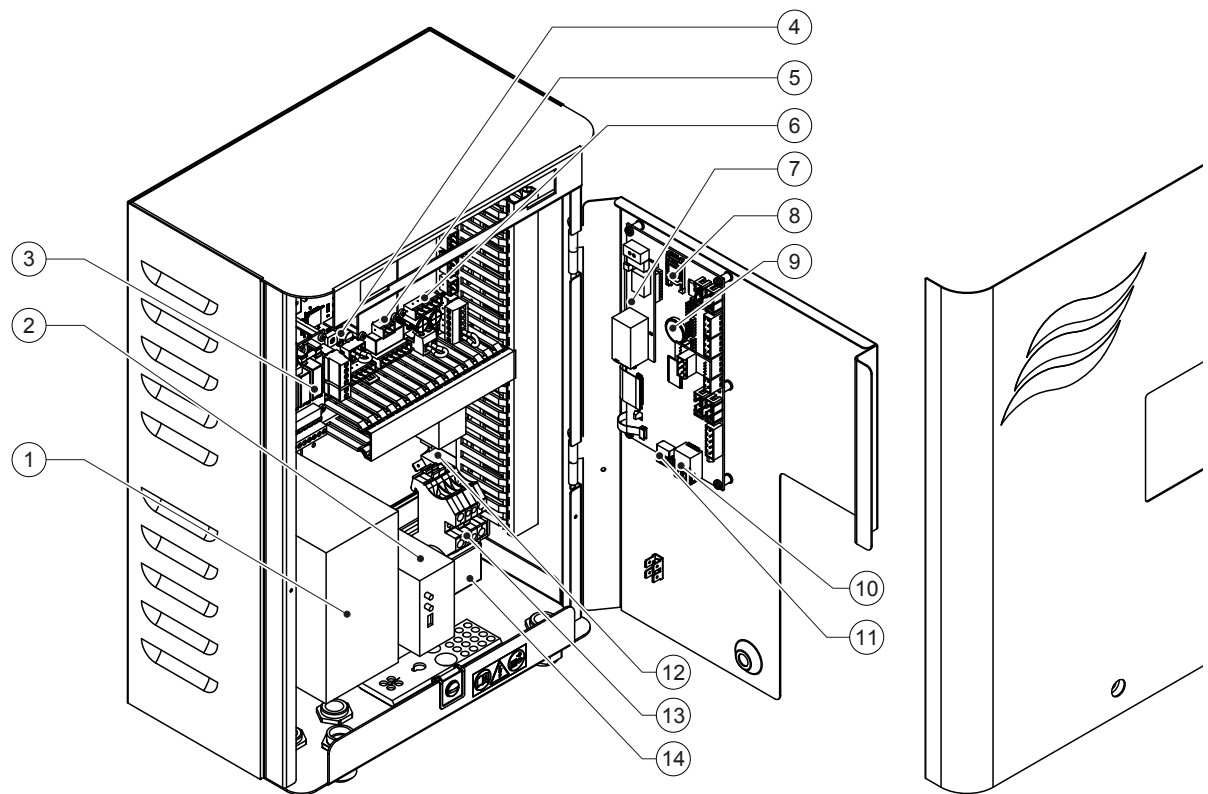

- | | | | |
|---|--|----|--|
| 1 | Frequency converter | 8 | Memory card |
| 2 | Leak monitoring (option) | 9 | Back-up battery (CR 2032, 3V) |
| 3 | Remote operating and fault indication board | 10 | RJ45 connector (ethernet interface) |
| 4 | Driver board | 11 | USB connector |
| 5 | Ag-Ionization board | 12 | Switch <Control unit On/Off> (operable from the outside) |
| 6 | Conductivity monitoring board | 13 | Terminals mains voltage supply |
| 7 | BMS Gateway board (option LonWorks,
BTL certified BACnet IP or BACnet MSTP) | 14 | Snap ferrite mains voltage supply |

Fig. 5: Overview control unit Condair DL (without internal cabling)

3.9 Overview central unit Condair DL

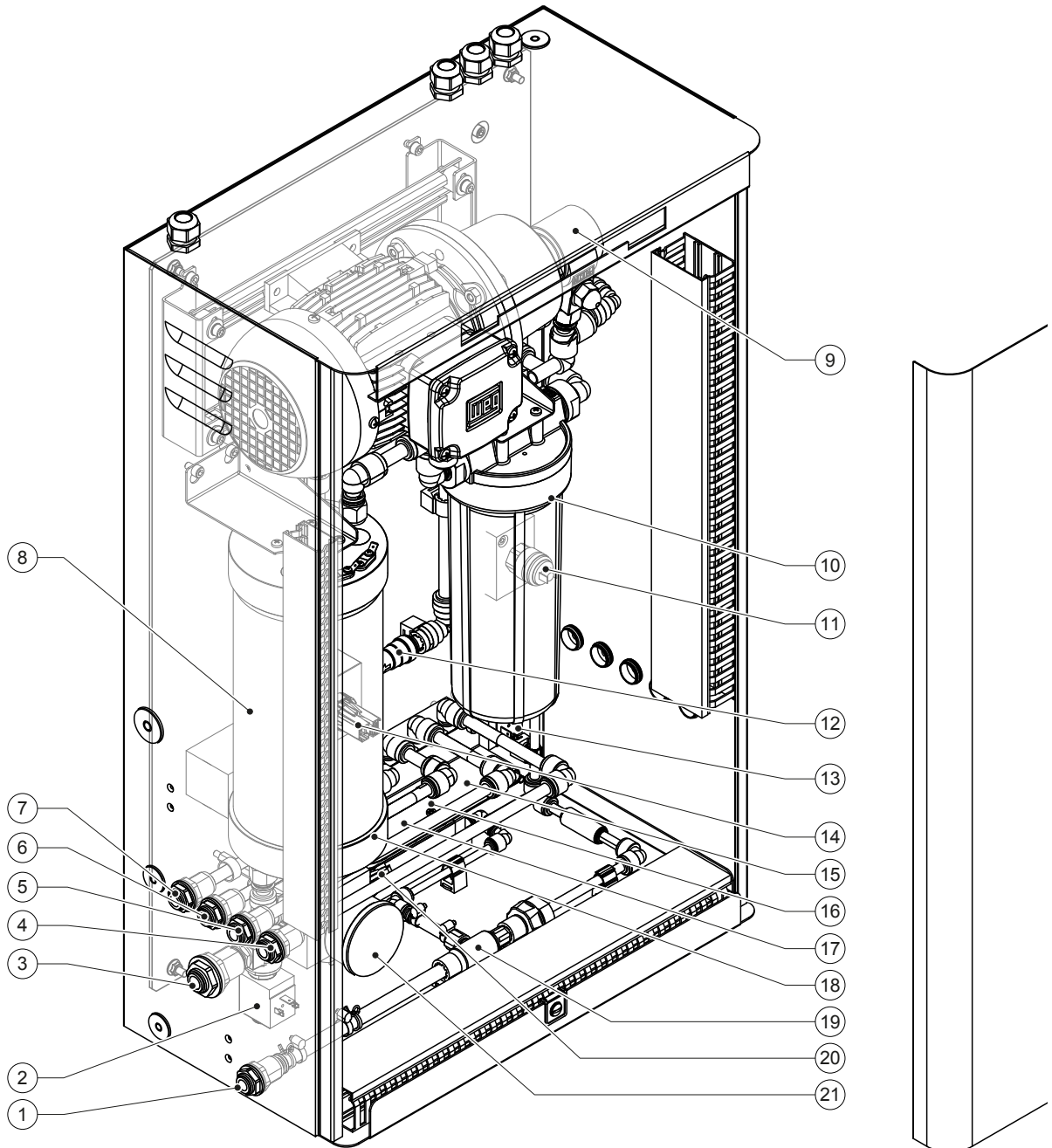

- | | | | |
|----|--|----|---|
| 1 | Water drain connector - plug-in coupling \varnothing 10 mm or 1/2" male thread adapter (supplied) | 11 | Pressure switch PS2 (Type A with sterile filter only) |
| 2 | Inlet valve | 12 | Check valve (Type A only) |
| 3 | Water supply connector - plug-in coupling \varnothing 12 mm or 1/2" male thread adapter (supplied) | 13 | Drain valve Y10 |
| 4 | Connector spray circuit 1 (Y5) | 14 | Pressure sensor PS5 |
| 5 | Connector spray circuit 2 (Y6) | 15 | Spray valve Y5 |
| 6 | Connector spray circuit 3 (Y7+Y9) | 16 | Spray valve Y6 |
| 7 | Connector spray circuit 4 (Y8+Y9) | 17 | Spray valve Y7 |
| 8 | Silver ionisation cartridge | 18 | Spray valve Y8 |
| 9 | Booster pump (Type A only) | 19 | Water jet pump |
| 10 | Sterile filter (option) | 20 | Pressure sensor PS4 |
| | | 21 | Manometer inlet pressure |

Fig. 6: Overview central unit Condair DL

4 Operation

The adiabatic air humidification system Condair DL may be commissioned and operated only by persons familiar with the adiabatic air humidification system Condair DL and adequately qualified. It is the owner's responsibility to verify proper qualification of the personnel.

4.1 First-time commissioning

The first-time commissioning must always be done by a service technician of your Condair representative or a well trained and authorised person of the customer. Therefore the current manual does not provide detailed information on this procedure.

The following steps are carried out upon first-time commissioning in the specified order:

- Inspecting the humidification unit, the control unit and the central unit for correct installation.
 - Inspecting the electrical installation
 - Inspecting the water installation
 - Flushing the water supply line and testing the water quality.
 - Checking direction of rotation of the booster pump and adjusting the relief valve of the booster pump.
 - Checking whether the spray circuits are connected to the corresponding nozzles and that all nozzles are spraying correctly.
 - Configuring the control unit or the humidification system Condair DL, respectively.
 - Carrying out test runs.
 - Fill in the commissioning protocol
- Note: a master of the commissioning protocol is included in the delivery or can be ordered from your Condair representative.

4.2 Display and operating elements

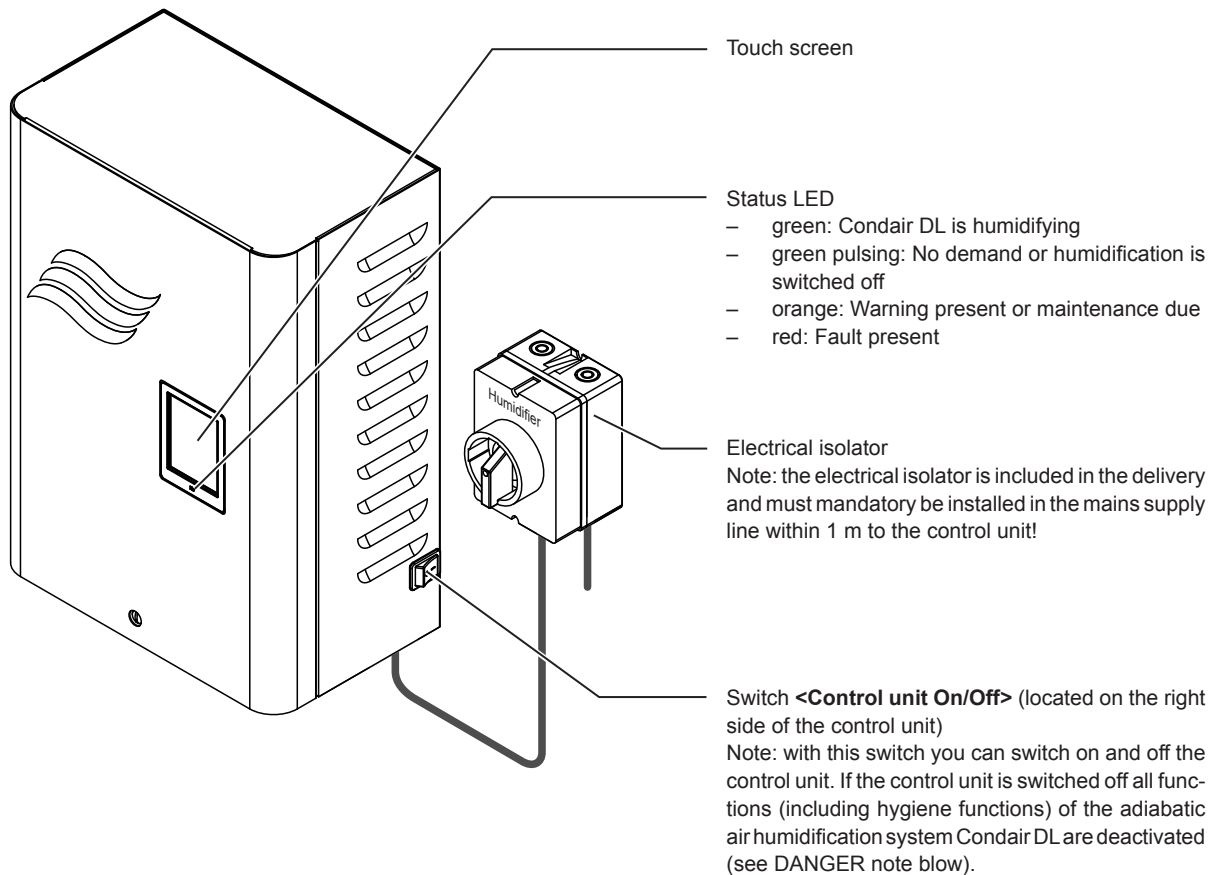

Fig. 7: Display and operating elements Condair DL



DANGER!
Risk of electric shock!

There is still mains voltage inside the control unit even when you switch off the <Control unit On/Off> switch. Therefore, the **electrical isolator must be switched off before open the control unit.**

4.3 Recommissioning after interruption of operation

The following description outlines the recommissioning procedure after an interruption of the operation (e.g. after servicing the system). It is assumed that first-time commissioning has been carried out properly by the service technician of your Condair representative. Proceed as follows to prepare the adiabatic air humidification system Condair DL for operation:

1. Examine the system components and installations for possible damage.



DANGER!

Damaged systems or systems with damaged components or installations may present danger to human life or cause severe damage to material assets.

Damaged systems and/or systems with damaged or faulty installations must not be operated.

2. Make sure the ceramic plates are correctly located and properly sealed.



WARNING!

An unsealed post-evaporation unit may lead to severe damage of material assets.

Put the system into operation only if the ceramic plates are correctly positioned and the post-evaporation unit correctly sealed.

3. **Switch on the electrical isolator in the mains supply line** (mains supply to control unit).
4. If closed, open shut-off valve in the water supply line.
5. Switch **<Control unit On/Off>** on the control unit to "**On**", and activate control unit via the external enable switch if necessary.
6. If the adiabatic air humidification system Condair DL has been disconnected from the mains for more than 48 hours the message "Out of Commissioning" appears. If this is the case proceed as follows:
 - Switch off control unit via the **<Control unit On/Off>** switch.
 - Close shut-off valve in the water supply line.
 - Disconnect the water supply line from the connector on the central unit.
 - Lead the open end of the water supply line into open funnel of the waster line of the building.
 - Open the shut-off valve in the water supply line and flush the supply line for at least 5 minutes. Close shut-off valve in the water supply line again. Reconnect the water supply line to the connector on the central unit, and open the shut-off valve.
 - Switch on control unit via the **<Control unit On/Off>** switch.

Note: After switching on the control unit the "Out of Commissioning" message appears again. Reset the message with the "Commissioning Reset" function in the service submenu (see [chapter 5.5.2](#)). Whether or not you reset the message the Condair DL is automatically switched to normal operating mode after 5 minutes.

7. If the sterile filter has been replaced, deaerate the sterile filter as described in [chapter 6.6](#).

The adiabatic air humidification system Condair DL is now in **normal operating mode** and the **standard operating display** is shown in the display.

Note: Further information on the operation of the Condair DL control software can be found in [chapter 5](#).

4.4 Notes on operation

4.4.1 Important notes on operation

- For hygiene reasons the drain valve opens **every 23 hours for approx. 300 seconds** in standby mode in order to flush water supply line.
- Humidification is not activated if the humidification request is below 11% (with 3 spray circuits) or below 5.8% (with 4 spray circuits), respectively.

4.4.2 Remote operating and fault indication

Via the relays on the operating and fault indication board the following operating status are indicated:

Activated remote indication relay	When?
"Error"	An error is present, operation is stopped or further operation is possible for a limited period of time only.
"Service"	One of the maintenance counter has elapsed. The corresponding maintenance must be performed.
"Humidification"	Demand present/humidification
"Unit on"	The humidification system is switched on and under voltage

4.4.3 Inspections during operation

During operation the adiabatic air humidification system Condair DL has to be inspected periodically. On this occasion check the following:

- the water systems for any leak.
- the components of the humidification system for correct fixing and any damage.
- the electric installation for any damage.
- the display for whether or not a warning or error message is present.

If the inspection reveals any irregularities (e.g. leak, error indication) or any damaged components take the adiabatic air humidification system Condair DL out of operation as described in [chapter 4.5](#). Then, have the malfunction be eliminated or the damaged component be replaced by a well trained specialist or a service technician from your Condair representative.

4.4.4 Flushing of the internal water system

Note: if an error message is active flushing of the internal water system is not possible.

To perform a flushing of the internal water system proceed as follows:



1. Press on the **<Drain>** button in the standard operating display. The "Manual" submenu appears.
2. Press on the **<Flushing>** button. The drain confirmation display appears.
3. Press on the **<Yes>** button to start the flushing of the water system. A possible running humidification process is interrupted. If your system is equipped with the external pipe flush option, valve Y4 opens first and the water supply line is flushed for a set period of time. Then, the inlet valve Y1 opens and the internal water system of the central unit is flushed via the drain valve Y10 (normally open valve). If your system is equipped with the air cleaning option, finally valve Y3 opens and the spray circuits are blown out one after the other, assumed there is no humidity demand present and the safety loop and the external enable contact (if applicable) are closed.

The progress bar in the display shows the current status of the flushing cycle. After flushing cycle has finished the unit returns to the "Manual" submenu.

In order to stop the flushing cycle press the **<Cancel>** button in the flushing progress window. The flushing cycle is stopped and the unit returns to the "Manual" submenu.

4.4.5 Performing a pressure release of the water system

Note: a pressure release can be performed even if a error message is active.



CAUTION!
Danger of flooding!

If a leak malfunction ("E54") is active, the leak must be repaired prior to perform a pressure release. Otherwise there is a danger of flooding when performing a pressure release.

4.4.6 To release the pressure in the water system of the central unit proceed as follows:

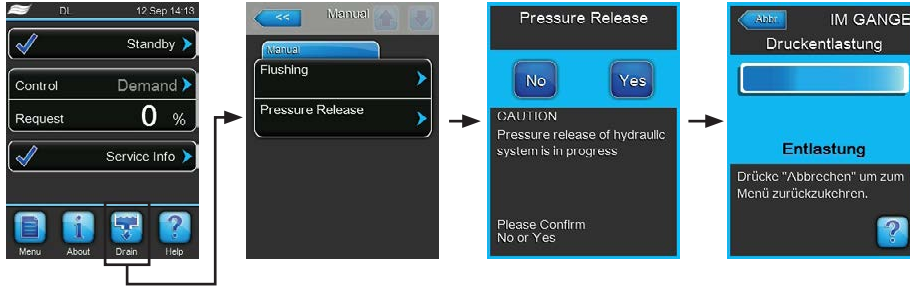

1. Close the shut-off valve in the water supply line.
2. Press on the **<Pressure Release>** button in the standard operating display. The "Manual" submenu appears.
3. Press on the **<Pressure Release>** button in the "Manual" submenu. The drain confirmation display appears.
4. Press on the **<Yes>** button to start the pressure release of the water system. The inlet valve Y1 and the drain valve Y10 open for approx. 10 minutes. Then, the unit returns to the "Manual" submenu.
Note: in order to stop the pressure release cycle press the **<Cancel>** button in the progress window. The pressure release cycle is stopped and the unit returns to the "Manual" submenu.

4.5 Decommissioning the system

In order to take the adiabatic air humidification system Condair DL out of operation (e.g. to perform maintenance works) perform the following steps:

1. Close the Shut-off valve in the water supply line.
Note: if you want to perform work on the water system release the pressure in the water system (see [chapter 4.4.5](#)). As soon as the error message "E22 Water Missing" appears stop the pressure release cycle.
2. Switch off **<Control unit On/Off>** switch on the control unit, and if applicable deactivate control unit via the external enable switch.
3. **Disconnect then control unit from the mains supply:** switch off electrical isolator in the mains supply line and secure electrical isolator in the "Off" position against accidentally switching on.



DANGER!
Risk of electric shock!

The frequency converter in the control unit of Type A systems with booster pump contains condensers, which under certain circumstances may remain loaded with a potentially deadly voltage for a certain amount of time, after the control unit has been separated from the mains. If work has to be carried out on the frequency converter and/or the booster pump wait at least 10 minutes after the control unit has been separated from the mains and make sure the appropriate contacts on the frequency converter and the terminals on the booster pump are free of voltage before starting any work on these components.

4. **Mind hygiene! Let the fan of the ventilation system run** until the humidification unit is **dry**.
5. If work has to be carried out on the humidification unit switch off the AHU and secure the system against accidentally being switched on.

Important information on extended periods of non-use

Important! For reasons of hygiene, we basically recommend that the control unit and the supplying RO system should be left switched on and only to switch off the humidification function via the control software (Main Menu > Service > Operation). With the system switched on, the water circuit is flushed at regular intervals and hence the build-up of germs is opposed.

If the adiabatic air humidification system Condair DL is not be used for a longer period of time observe the following points:

- **Mind hygiene! Drain all water conduits.**
Note: Regarding the emptying of the water supply line from the RO system please refer to the specifications of the manufacturer of the RO system.
- Remove the sterile filter, drain the water in the filter housing, dry filter housing and install a new filter cartridge.
- Drain the Ag ionisation cartridge.
- For safety reasons the **post-evaporation elements should remain in their working position**, even if the humidifier is not used for an extended period. This prevents the water from being sprayed directly into the duct in case the humidifier is powered up inadvertently.

5 Operating the Condair DL control software

5.1 Standard operating display

After switching on the control unit and the automatic system test the control unit is in **normal operating** mode and the **standard operating display** is shown.

Note: the appearance of the standard operating display depends on the current operating status and the configuration of the humidity regulation of the system and can deviate from the display shown below.

The standard operating display is structured as follows:

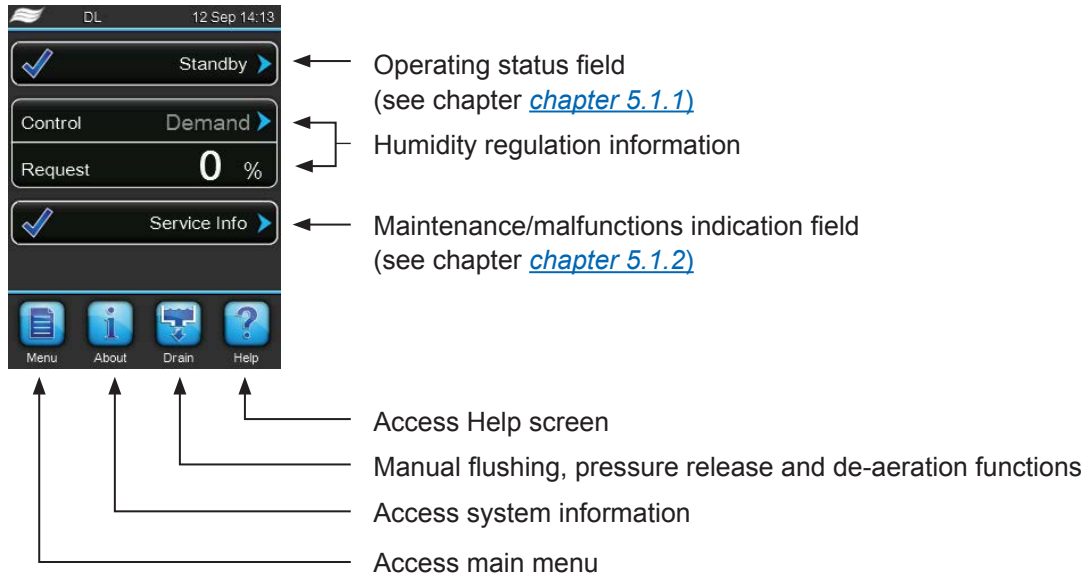













Fig. 8: Standard operating display







5.1.1 Operating status indication



The following operation status indications may appear during operation:

Operating status indication	Description
 Initializing ▶	The control is initialising.
 Ready ▶	The humidification system is flushed and ready to humidify immediately if a demand is present.
 Standby ▶	No humidity demand for more than 60 minutes the humidification system is in standby mode. The water system is flushed automatically for 120 seconds before the next humidification takes place.
 Flushing ▶	The water is being flushed.
 Humidifying ▶	The humidification system is humidifying.
 Filling ▶	The humidification system is filling and deaerating after water shortage has occurred.
 Cond.Flush ▶	The conductivity of the supply water is beyond of the admissible range, the water system is flushed automatically for a certain period of time.
 Remote Off ▶	The humidification system was stopped via the external enable switch.
 Switched Off ▶	The humidification function is deactivated via the control software (Main Menu > Service > Operation). The hygiene functions (regular flushing of the water system) remain still active.
 Air Prs.Cleaning ▶	The optional air cleaning is in progress.
 Temp. Flush ▶	The water temperature is too high or near the freezing point. The water system is flushed for a certain time.
 Stopped ▶	The humidification system is stopped due to a malfunction which obviates further operation. Additionally "Warning" or "Fault" is displayed in the maintenance and malfunction field.













5.1.2 Maintenance and malfunction indications

The following maintenance and malfunction indications may appear during operation:

Operating status indication	Description
 Service Info ▶	No malfunction present. By pressing on the indication field the service menu can be accessed.
 Activation Code ▶	The activation code needs to be entered to get the system running (see chapter 5.5.2).
 Out of Commissioning ▶	This message appears after switching on, if the control unit has been isolated from the mains supply for more than 48 hours. The humidification system is blocked for 5 minutes. Before operation the RO water supply line to the central unit must be flushed. The commissioning warning is reset automatically after 5 minutes or you can reset the warning in the "Service" submenu (see chapter 5.5.2).
 Refill Disinfection ▶	The tank of the disinfection system is empty. The tank must be refilled.
 Service ▶	The system service is due. Perform system service and reset maintenance counter.
 Replace Ag cartridge ▶	The capacity counter of the silver ionizing cartridge indicates 0 Ah. The silver ionizing cartridge needs to be replaced. If the silver ionization cartridge is not replaced within 7 days and the service message is reset, the humidification system will stop.
 Disinfection ▶	The Day counter for the disinfection has expired. Perform a disinfection and reset the counter. Note: This warning only appears if the optional daily counter for disinfection is activated.

Operating status indication	Description
	A malfunction with status "Warning" is active. Additionally the yellow LED lights. Depending on the malfunction the humidification system is either be stopped or stays operable for a certain period of time.
	A malfunction with status "Fault" is active. Additionally the red LED lights. Depending on the malfunction the humidification system is either be stopped or stays operable for a certain period of time.

5.2 Navigating/Operating the Condair DL control software

Navigation element	Action
	Accessing main menu
	Accessing system information
	Performing manual drain/pressure release
	Accessing help screen
	If you press on a field with a blue arrow symbol a new screen with additional information or settings appears.
	This symbol on the left side of the operating status field and of the maintenance/malfunctions indication field indicates, that the system is working ok.
	This symbol on the left side of the the maintenance/malfunctions indication field indicates, that a Warning is present. Press on the field to get further information.
	This symbol on the left side of the operating status field and of the maintenance/malfunctions indication field indicates, that a Fault is present (additionally the LED lights red). Press on the field to get further information.
	Jumps back to previous screen (Cancel and back)
	Scroll up/down in the present window
	Increase/decrease value
	Delete shown value
	Confirm set value or selected option

5.3 Information functions

5.3.1 Accessing support information



In the standard operating display press the **<Help>** button.

The screen with the support information appears.

5.3.2 Accessing system information

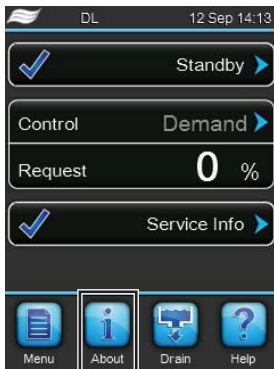

In the standard operating display press the **<About>** button.

The system information screen appears. Use the arrow buttons to scroll up and down within the system information screen to access the different operating data.

Service Tab



- **Operating Hours:** Operating hours since initial commissioning of the system.
- **Next Service:** Remaining time until next maintenance of the system must be performed.
- **Next Disinfection:** Remaining time until next disinfection in days. Note: this info field appears only if the optional daily counter for disinfection is activated in the engineering level of the control software.
- **Remain. Capacity:** Remaining capacity of the silver ionization cartridge in Ah.

Operating Tab

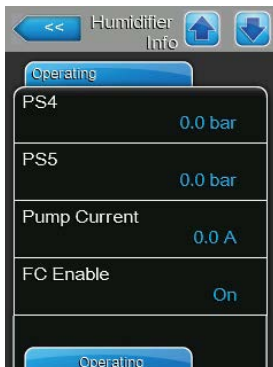
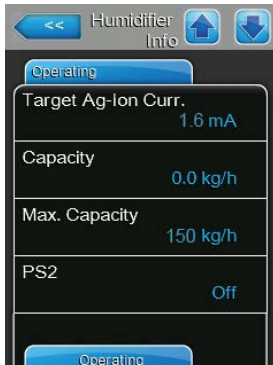
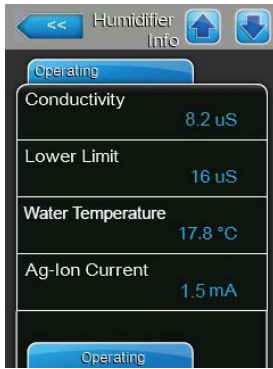

- **Conductivity:** Actual conductivity of the supply water in $\mu\text{S}/\text{cm}$.
Note: During the periodical system flushings the conductivity is displayed temporarily with 0.0 μS . Always wait, until the system is humidifying, in order to read the conductivity value!
- **Lower Limit:** Set limit value for the water conductivity in $\mu\text{S}/\text{cm}$.
- **Water Temperature:** Actual temperature of the supply water in $^{\circ}\text{C}$ or $^{\circ}\text{F}$.
Note: this info field appears only if the "water temperature monitoring" option is installed and activated in the engineering level of the control software.
- **Ag-Ion Current:** Actual current of the Ag ionization in mA.
- **Target Ag-Ion Curr.:** Set nominal current for Ag ionization in mA.
- **Capacity:** Actual capacity of the humidification system in kg/h.
- **Max. Capacity:** Maximum capacity of the humidification system in kg/h.
- **PS2:** Actual status of the optional pressure switch PS2 when operating the humidification system Condair DL type A with sterile filter (On= pressure present, Off= no pressure present).
- **PS4:** Actual water inlet pressure in bar.
- **PS5:** Actual atomization pressure of the water in bar (Type A with booster pump only).
- **Pump current:** Actual current of the booster pump in A.
- **FC Enable:** Actual status frequency converter enable contact (On= power to pump motor enabled, Off= power to pump motor disabled).
- **Y1:** Actual operating status of the inlet valve "Y1".
- **Y2:** no function.
- **Y3:** Actual operating status of the external valve "Y3" of the air cleaning option.
- **Y4:** Actual operating status of the external valve "Y4" of the external pipe flush option.

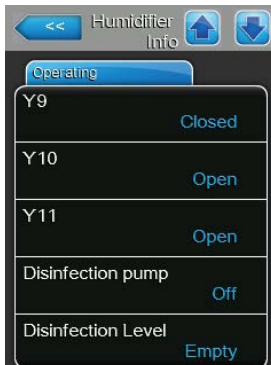

- **Y5:** Actual operating status spray valve "Y5".
- **Y6:** Actual operating status spray valve "Y6".
- **Y7:** Actual operating status spray valve "Y7".
- **Y8:** Actual operating status spray valve "Y8".
- **Y9:** Actual operating status spray valve "Y9".
- **Y10:** Actual operating status drain valve (open when de-energized).
- **Y11:** Actual operating status optional auxiliary outlet valve (open when de-energized).
Note: this info field appears only if the optional auxiliary outlet valve is installed and activated in the engineering level of the control software.
- **Disinfection pump:** Actual operating status of the external disinfection pump (On= pump running, Off= pump stopped).
Note: this info field appears only if the the control of the external disinfection pump is activated in the engineering level of the control software.
- **Disinfection Level:** Actual level of the disinfection liquid in the disinfection tank.
Note: this info field appears only if the the control of the external disinfection pump is activated in the engineering level of the control software.

General Tab

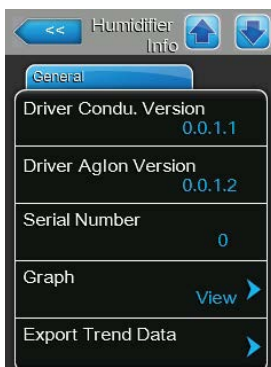

- **Humidifier Model:** Designation of the humidifier model.
- **Device Type:** Device type ("Hum"= Humidifier without booster pump, "Hum+FC"= Humidifier with booster pump)
- **Software Version:** Actual Version of the control software.
- **Driver Board A Version:** Actual software version of the driver board.
- **Driver Condu. Version:** Actual software version of the conductivity monitoring board (conductivity supply water).
- **Driver Aglon Version:** Actual software version of the Ag ionization board.
- **Serial Number:** Serial number of the humidification system.
- **Graph:** With this function you can access the graphical display of the performance diagram of the Condair DL.
- **Export Trend Data:** With this function you can save the data of the performance diagram as .csv file to a USB memory stick (FAT32 formatted).
Note: before carrying this function, a FAT32 formatted USB memory stick must be connected to the USB port on the control board.

Features Tab



- **Manual Capacity A:** Set capacity limitation in % of the maximum capacity.
- **Leak Sensor:** Shows whether the leak monitoring option is activated ("On") or not ("Off").
- **Disinfection:** Shows whether the control of the external disinfection pump is deactivated ("Off") or activated with time controlled ("Time") or with impulse controlled ("Impulse") operation of the disinfection pump.
- **Air Cleaning:** Shows whether the air cleaning option is activated ("On") or not ("Off").
- **Ext. Pipe Flush:** Shows whether the external pipe flush option is activated ("On") or not ("Off").
- **Softstart:** Shows whether the softstart function is activated ("On") or not ("Off").

Network Tab

The information shown in the "Network" tab varies depending on whether a BAS (building automation system) communication protocol is enabled, and which communication protocol is selected. If no BAS protocol is enabled, then only "Online Status" and "IP Address" are shown.

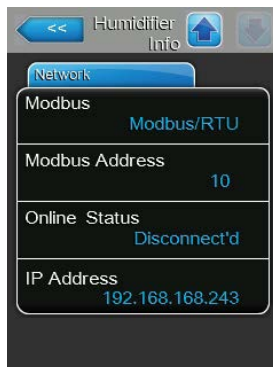

Modbus Network

- **Modbus:** shows the current status of the Modbus communications protocol. Note: This menu item appears only if the Modbus communication protocol is enabled. Detailed information on Modbus communication can be found in the separate Modbus addendum manual. This manual can be requested from your Condair representative.
- **Modbus Address:** shows the Modbus address of the Condair DL. Note: This menu item appears only if the Modbus communication protocol is enabled, and the BACnet communication protocol is disabled.
- **Online Status:** shows the connection status of the Condair DL to Condair Online ("Connected" or "Disconnect'd").
- **IP Address:** shows the IP address of the Condair DL.



BACnet MSTP Network / BACnet IP Network

- **BACnet:** shows the currently selected BACnet onboard communication protocol ("MSTP" or "BACnet/IP"). Note: This field appears only if the BACnet communication protocol is enabled. Further information on BACnet IP and BACnet MSTP communication can be found in the separate BACnet addendum manual. This manual can be requested from your Condair representative.

BACnet MSTP Network

- **BACnet MSTP MAC:** shows the actual BACnet MSTP MAC address for the Condair DL. Note: This field appears only if "BACnet MSTP" is enabled.

BACnet IP Network

- **Node ID:** shows the actual BACnet node ID for the Condair DL. Note: This field appears only if "BACnet IP" is enabled.
- **Online Status:** shows the connection status of the Condair DL to Condair Online ("Connected" or "Disconnect'd").
- **IP Address:** shows the IP address of the Condair DL.



5.4 Configuration

5.4.1 Accessing the "Configuration" submenu



Password:

5.4.2 Activating/deactivating and configuration of unit functions – "Features" submenu

In the "Features" submenu you can activate/deactivate and configure unit functions.

Operation Tab

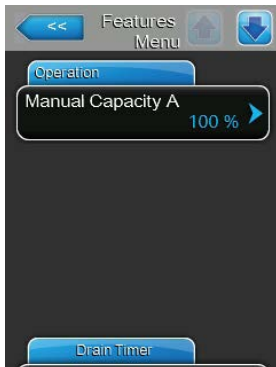

- **Manual Capacity A:** with this setting you determine the capacity limitation in relation to maximum capacity in %.

Factory setting: 100 %

Options: 20 ... 100 %

Drain Timer Tab



- **Function:** with this setting you can activate ("On") or deactivate ("Off") the timer controlled flushing of the water system.
Note: during the timer controlled flushing of the water system, first the water supply line is flushed via the external pipe flush valve Y4, assumed your system is equipped with the external pipe flush option. Then, the inlet valve Y1 opens and the internal water system of the central unit is flushed via the drain valve Y10 (normally open valve). Finally the air cleaning valve Y3 opens and the spray circuits are blown out one after the other, assumed your system is equipped with the air cleaning option.
- **Start Time:** with this setting you determine the time of day, at which the timer controlled flushing of the water system is to be carried out.
Note: if at the point in time, on which the timer controlled flushing is to be carried out, a humidity demand is present, the flushing is omitted.

5.4.3 Humidity control Settings – "Control Settings" submenu

In the "Control Settings" submenu you determine the control settings for the adiabatic air humidification system Condair DL. The control settings available depend on the selected signal source and the control mode.

Basic Tab

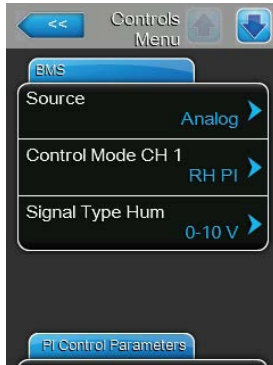

- **Source:** with this setting you determine whether the control signal comes from an analogue source (signal of a humidity sensor or demand signal from an external humidity controller) or via Modbus.
Factory setting: **Analog**
Options: **Analog** (Analog Sensor/humidity controller signal)
Modbus (Modbus signal)
BACnet (Signal via BACnet)
- **Control Mode CH 1:** with this setting you determine the type of controller used with the adiabatic air humidification system Condair DL.
Factory setting: **Demand**
Options: **On/Off** (external On/Off humidistat)
Demand (external continuous controller)
RH P (internal P controller)
RH PI (internal PI controller)
- **Signal Type Hum:** with this setting you determine the control signal with which the humidification system is controlled.
Note: this setting appears only if signal source is set to "Analog" and "Control Mode CH 1/3" is set to "Demand", "RH P" or "RH PI".
Factory setting: **0-10 V**
Options: **0-5V, 1-5V, 0-10V, 2-10V, 0-20V, 0-16V, 3.2-16V, 0-20mA, 4-20mA**

PI Control Parameter Tab



- **Setpoint:** with this setting you set the humidity setpoint for the internal P/PI controller in %rh.
Note: this setting appears only if the "Control Mode CH 1/3" is set to "RH P" or "RH PI".
Factory setting: **40 %rh**
Options: **0 ... 95 %rh**
- **Band Channel 1 :** with this setting you set the proportional range for the internal P/PI controller in %rh.
Note: this setting appears only if the "Control Mode CH 1/3" is set to "RH P" or "RH PI".
Factory setting: **15 %rh**
Options: **6 ... 65 %rh**
- **ITime Channel 1:** with this setting you set the integral time for the internal P/PI controller.
Note: this setting appears only if the "Control Mode CH 1/3" is set to "RH PI".
Factory setting: **5 minutes**
Options: **1 ... 60 minutes**

Sensor Broken Tab

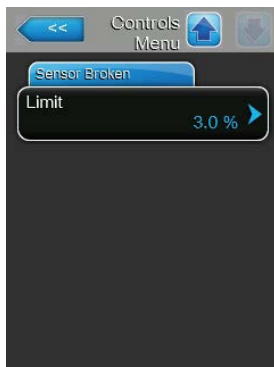

- **Limit:** with this setting you set the minimum signal value in per cent of the maximum signal value of the humidity sensor, if undershot a sensor interruption message (Fault "E32") is triggered.
Note: this setting appears only if the "Control Mode CH 1/3" is set to "RH P" or "RH PI".
Factory setting: **3 %**
Options: **0.0 ... 10.0 %**

5.4.4 Basic settings – "General" submenu

In the "General" submenu you determine the basic settings for operating the Condair DL control unit.

Basic Tab

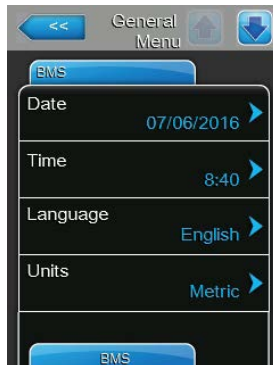

- **Date:** With this setting you determine the current date in the set format ("MM/DD/YYYY" or "DD/MM/YYYY").
Factory setting: **00/00/0000**
- **Time:** With this setting you set the current hour of the day in the set time format ("12H" or "24H").
Factory setting: **12:00**
- **Language:** With this setting you determine the dialogue language.
Factory setting: **depending on the country**
Options: **different dialogue languages**
- **Units:** With this setting you determine the desired unit system.
Factory setting: **depending on the country**
Options: **Metric or Imperial**



- **Contrast:** With this setting you determine the desired value for the display contrast.
Factory setting: **8**
Options: **1 (weak contrast) ... 31 (strong contrast)**
- **Brightness:** With this setting you determine the desired value for the display brightness.
Factory setting: **52**
Options: **1 (dark) ... 100 (white)**
- **LED Brightness:** with this setting you determine the desired value for the brightness of the operation indication LED.
Factory setting: **52**
Options: **1 (weak) ... 100 (bright)**

Time/Date Tab



- **Date Format:** With this setting you determine the desired date format.
Factory setting: **DD/MM/YYYY**
Options: **DD/MM/YYYY or MM/DD/YYYY**
- **Clock Format:** With this setting you determine the desired time format.
Factory setting: **12H**
Options: **24H (24 hours, display 13:35) or 12H (12 hours, display: 01:35 PM)**

5.4.5 Communication settings – "Communication" submenu

In the "Communication" submenu you determine the parameters for digital communication protocols.

Network Parameters Tab



The following network settings are used only for the communication via the integrated BACnet IP interface.

- **IP Type:** with this setting you determine whether you want to assign the IP Address, the Subnet Mask, the Standard Gateway as well as the Primary and Secondary DNS address as fixed values or whether these should be dynamically assigned via a DHCP server.

Note: after 5 unsuccessful attempts at obtaining an address with DHCP the system will revert to fixed assignment

Factory setting: **DHCP**

Options: **DHCP** (dynamic assignment)

Fixed (fixed assignment)

- **IP Address:** This field shows the actual IP address of Condair DL assigned manually or assigned by a DHCP server.
If the parameter "IP Type" is set to "Fixed", the IP address of Condair DL can be set via this field. If the parameter "IP type" is set to "DHCP", the IP address of Condair DL is assigned by a DHCP server.
- **Subnet Mask:** This field shows the actual subnet mask of the IP network assigned manually or assigned by a DHCP server.
If the parameter "IP Type" is set to "Fixed", the subnet mask can be set via this field. If the parameter "IP type" is set to "DHCP", the subnet mask is assigned by a DHCP server.
- **Default Gateway:** This field shows the actual IP address of the default gateway assigned manually or assigned by a DHCP server.
If the parameter "IP Type" is set to "Fixed", the IP address of the default gateway can be set via this field. If the parameter "IP type" is set to "DHCP", the IP address of the default gateway is assigned by a DHCP server.
- **Primary DNS:** This field shows the actual IP address of the primary domain name server (DNS) assigned manually or assigned by a DHCP server.
If the parameter "IP Type" is set to "Fixed", the IP address of the primary domain name server can be set via this field. If the parameter "IP type" is set to "DHCP", the IP address of the primary domain name server is assigned by a DHCP server.
- **Secondary DNS:** This field shows the actual IP address of the secondary domain name server (DNS) assigned manually or assigned by a DHCP server.
If the parameter "IP Type" is set to "Fixed", the IP address of the secondary domain name server can be set via this field. If the parameter "IP type" is set to "DHCP", the IP address of the secondary domain name server is assigned by a DHCP server.
- **MAC Address:** Factory set MAC Address (Media Access Control) of Condair DL. Not modifiable.
- **Host Name:** Host Name of Condair DL automatically generated by the control. Format: "IC_"+"Serial number of Condair DL". Not modifiable.

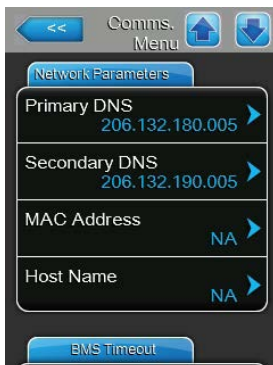

BMS Timeout Tab

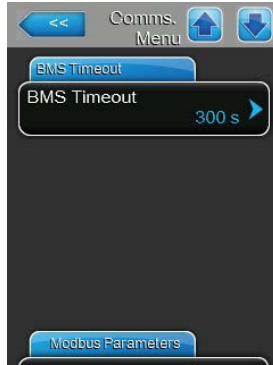

- **BMS Timeout:** with this setting you determine the maximum time the humidifier will wait with no communication from the BMS network before a BMS timeout warning is generated.
Factory setting: **300 s**
Setting range: **1 ... 300 s**

Modbus Parameters Tab

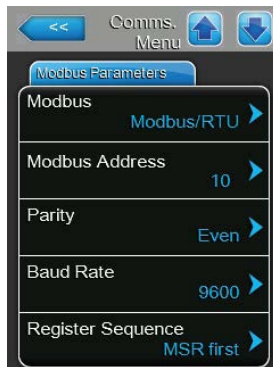

- **Modbus:** with this setting you can activate "**Modbus/RTU**" or "**Modbus/TCP**" communication via a Modbus network or deactivate ("Off") Modbus communication.
Factory setting: **Modbus/RTU**
Options: **Off, Modbus/RTU or Modbus/TCP**

Important: regarding the setting of the individual Modbus parameters as well as the wiring of the Condair DL for the Modbus communication, please observe the instructions in the separate Modbus addendum manual. This manual can be requested from your Condair representative.

BACnet Parameters Tab



- **BACnet:** with this setting you can activate ("MSTP" or "BACnet/IP") or deactivate ("Off") the communication via the integrated BACnet interfaces.
Factory setting: **Off**
Options: **Off** (BACnet interface deactivated)
MSTP (BACnet MSTP via RS 485 interface)
BACnet/IP (BACnet/IP via RJ45 interface)

Important: regarding the setting of the individual BACnet parameters as well as the wiring of the Condair DL for the BACnet Ip or BACnet MS/TP communication, please observe the instructions in the separate BACnet addendum manual. This manual can be requested from your Condair representative.

Remote Fault Indication Tab



- **Indication:** With this setting you determine whether maintenance messages ("Service") only or all Warning messages ("Warning") are outputted via the service relay of the remote operating and fault indication board.
Factory setting: **Service**
Options: **Service or Warning**
- **Safety Loop:** With this setting you determine whether an Fault ("On") or a Warning ("Off") is triggered when the external safety loop is open.
Factory setting: **Off**
Options: **Off or On**
- **Ag+ Exchange:** With this setting you determine whether an Fault ("On") or a Warning ("Off") is triggered when the capacity counter of the silver ionization cartridge has elapsed.
Note: However, 7 days after the capacity counter of the silver ionization cartridge has elapsed always a fault message is triggered.
Factory setting: **Fault**
Options: **Fault or Warning**

5.5 Maintenance functions

5.5.1 Accessing the "Service" submenu

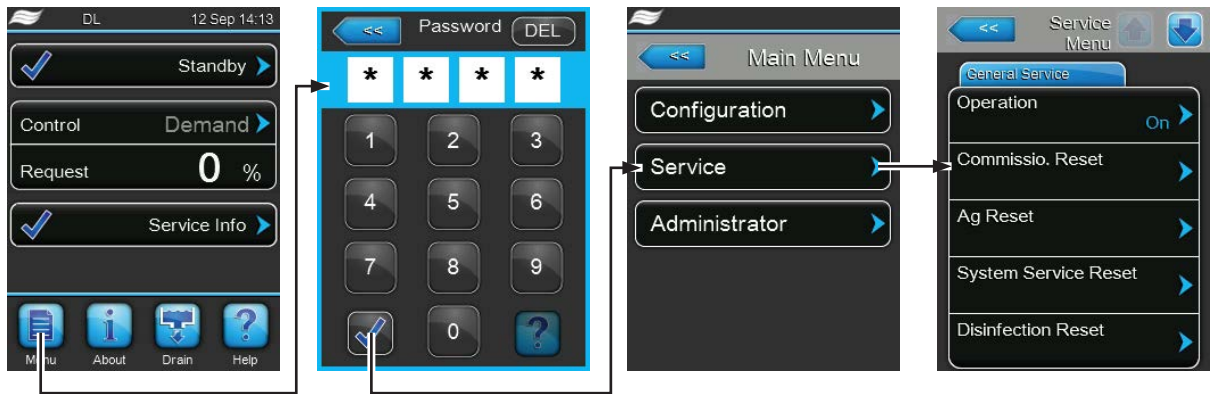

Password: 8808

5.5.2 Performing maintenance functions – "Service" submenu

In the "Service" submenu you can enter the activation code, access and export the fault and maintenance histories and perform different diagnostic functions.

General Service Tab

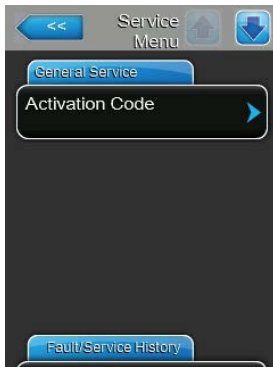

– Activation Code:

Note: This menu item appears only if the activation code message is shown at system startup.

Via the "Activation Code" function you can unlock the adiabatic air humidification system Condair DL if it is locked ex factory with an activation code. Once the activation code has been entered and confirmed the menu item is not shown anymore.

After pressing on the "Activation Code" button a confirmation window appears where you have to confirm the activation. Afterwards you can enter the four-digit activation code and confirm it.

Note: Contact your Condair representative to get the activation code.

General Service Tab



- **Operation:** with this function you can turn on or off the Condair DL humidification operation. The system remains energized and all hygiene functions will still be carried out.

Factory Setting: **On**

Setting Range: **On or Off**

- **Commissio. Reset:** with this function you can reset the "Commissioning" message, which appears if the control unit has been disconnected from the mains for more than 48 hours. After pressing on the "Commissioning Reset" button a confirmation window appears where the resetting must be confirmed.

Note: after resetting the control unit must be connected to the mains for at least 15 minutes, otherwise the "Commissioning" message appears on the next startup again.

- **Ag Reset:** with this function you can reset the Ag maintenance message or the Ag maintenance counter, respectively. After pressing on the "Ag Reset" button a confirmation window appears where the resetting must be confirmed.

- **System Service Reset:** with the "System Service Reset" function you can reset the service message or the service counter, respectively. After pressing on the "System Service Reset" button a confirmation window appears where the resetting must be confirmed.

- **Disinfection Reset:** with the "Disinfection Reset" function you can reset the disinfection message or the disinfection day counter, respectively. After pressing on the "Disinfection Reset" button a confirmation window appears where the resetting must be confirmed.

Note: This menu item appears only if the optional daily counter for disinfection has been activated in the engineering level of the control software.

Fault/Service History Tab



Note: the fault and maintenance events stored can be correctly analyzed only if the data and the time of day are correctly set.

- **Fault History:** with the function "Fault History" you can access the fault history list where the last 40 fault events are stored. After pressing on the "Fault History" button the fault history list appears.

- **Service History:** with the function "Service History" you can access the service history list where the last 40 service events are stored. After pressing on the "Service History" button the service history list appears.

- **Export History:** with the function "Export History" you can export the fault and service history list to a FAT32 formatted USB memory stick via the USB port on the control board. Detailed information can be found in [chapter 7.5](#).

Diagnostics



- **Input Diagnostics:** with the "Input Diagnostics" function you can access the "Input Diagnostics" submenu where you can view different current input values the control system is using. Detailed information on the individual input diagnostic functions can be found in [chapter 5.5.2.1](#).
- **Relay Diagnostic:** with the "Relay Diagnostic" function you can access the "Relay Diagnostic" submenu where you can activate or deactivate the relays of the optional remote operating and fault indication board. Detailed information on the individual relay diagnostic functions can be found in [chapter 5.5.2.2](#).

Note: By accessing the "Relay Diagnostic" submenu the humidification system is automatically switched to standby operation.

5.5.2.1 Input diagnostic functions – "Input Diagnostics" submenu

The following input values can be viewed after accessing the "Input Diagnostics" submenu.

Note: the input values can be accessed and viewed too, via the "Service Info" selection field in the standard operating display.

Control Tab



- **Humidity Control:** Actual demand signal in %
- **Safety Loop:** Actual status of the external safety loop ("Off"= safety loop open, "On"= safety loop closed).
- **Control Enable:** Actual status of the external enable switch, if present ("Off"= switch open, "On"= switch closed).

Hydraulic Tab

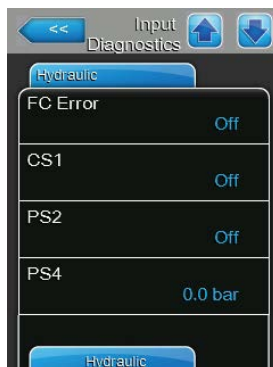

- **FC Error:** Actual status of the error relay of the frequency converter ("Off"= frequency converter switched off or error present, "On"= Frequency converter switched on and no error present)
- **CS1:** Actual status of the external flushing contact - K2 on wiring diagram ("Off"= external flushing contact open, "On"= external flushing contact closed).
- **PS2:** Actual pressure status after sterile filter ("Off"= no pressure present, "On"= pressure present).
- **PS4:** Actual water inlet pressure in bar.

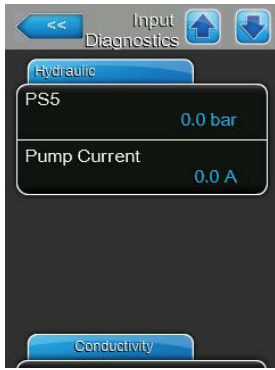

- **PS5:** Actual nozzle pressure in bar.
- **Pump Current:** Actual current of the booster pump motor

Conductivity Tab

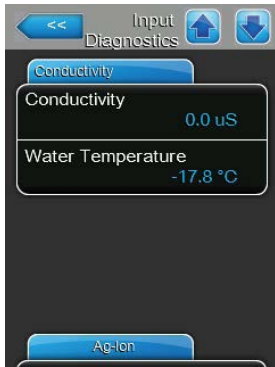

- **Conductivity:** Actual conductivity of the supply water in $\mu\text{S}/\text{cm}$.
Note: During the periodical system flushings the conductivity is displayed temporarily with 0.0 μS . Always wait, until the system is humidifying, in order to read the conductivity value!
- **Water Temperature:** Actual temperature of the supply water in $^{\circ}\text{C}$ or $^{\circ}\text{F}$.
Note: the actual water temperature is shown correctly only if the "water temperature monitoring" option is installed and activated in the engineering level of the control software.

Ag-Ion Tab



- **Ag-Ion Current:** Actual current of the Ag ionization in mA

Disinfection pump Tab



- **Disinfection Level:** Actual level of the disinfection liquid in the disinfection tank ("ok"= level in the tank ok, "Empty"= tank is empty).
Note: This diagnostic function appears only, if the control of the external disinfection pump is activated in the engineering level of the control software.

Hygiene&Safety Tab

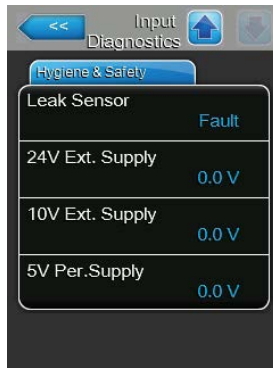

- **Leak Sensor:** Actual status of the leak monitoring input ("ok"= no leak present, "Fault"= leak detected).
- **24V External Supply:** Actual voltage of the external 24 V supply
- **10V External Supply:** Actual voltage of the external 10 V supply
- **5V Per.Supply:** Actual voltage of the external 5 V supply

5.5.2.2 Relay diagnostic functions – "Relay Diagnostics" submenu

The following relay diagnostic functions are available after accessing the "Relay Diagnostics" submenu.

General Tab

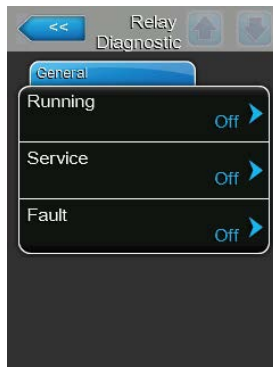

- **Running:** with this function you can activate ("On") and deactivate ("Off") the relay "Running" on the remote operating and fault indication board.
- **Service:** with this function you can activate ("On") and deactivate ("Off") the relay "Service" on the remote operating and fault indication board.
- **Fault:** with this function you can activate ("On") and deactivate ("Off") the relay "Fault" on the remote operating and fault indication board.

5.6 Administration settings

5.6.1 Accessing "Administrator" submenu

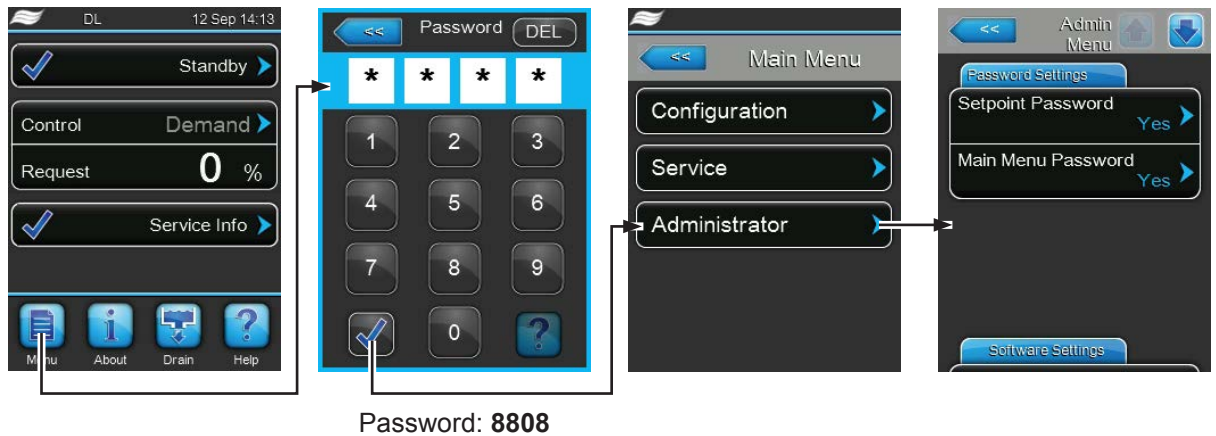

5.6.2 Switching on/off password protection and software updates function - submenu "Administrator"

In the "Administrator" submenu you can activate and deactivate the password protection for the main menu and the setpoint, and download software for options and software updates via a USB stick connected to the USB connector.

Password settings Tab

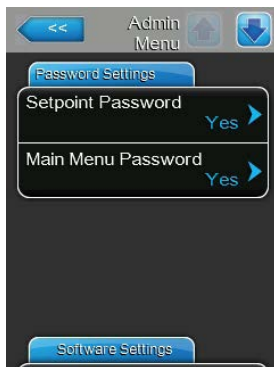

- **Setpoint Password:** with the function "Setpoint Password" you can protect the setpoint input screen with the user password "8808" against unauthorized access ("Yes") or not ("no").
- **Main Menu Password:** with the function "Main Menu Password" you can protect the access to the main menu with the user password "8808" against unauthorized access ("Yes") or not ("no").

Software Update Tab



- **Software-Update:** with the function "Software Update" you can update the control software of the integrated controller. See information in [chapter 6.8](#).
- **Driver Board A Update:** with the function "Driver Board A Update" you can update the driver board software. See information in [chapter 6.8](#).
- **Driver Condu. Update:** with the function "Driver Condu. Update" you can update the conductivity board software. See information in [chapter 6.8](#).
- **Driver Aglon Update:** with the function "Driver Aglon Update" you can update the Ag ionization board software. See information in [chapter 6.8](#).

Software Settings Tab



- **Load Contact Info Page:** this function allows you to upload new contact information data (which are displayed when pressing the <Help> button) from a USB memory stick connected to the USB port on the control board. Note: Ask your Condair representative for the appropriate contact data file.
- **Manually Load Contact Info:** this function allows you to manually change/enter contact information data (which are displayed when pressing the <Help> button).
- **Load Logger Definition:** this function allows logging of system parameters with a FAT32 formatted USB memory stick connected to the USB port on the control board. A factory supplied access file is required to enable operation.

6 Maintenance and Replacement of components

6.1 Important notes on maintenance

Qualification of personnel

All maintenance work must be carried out only by **well qualified and trained personnel authorised by the owner**. It is the owner's responsibility to verify proper qualification of the personnel.

General notes

The instructions and details for maintenance work must be followed and upheld. Only carry out the maintenance work described in this documentation.

The adiabatic air humidification system Condair DL must be maintained in the prescribed intervals, the cleaning work must be carried out correctly.

Only use original spare parts from your Condair representative to replace defective parts or parts which have elapsed their lifetime.

Safety



DANGER!
Risk of electric shock!

Before carrying out any maintenance work take the adiabatic air humidification system Condair DL out of operation as described in [chapter 4.5](#) and secure the system against inadvertent power-up. In addition take AHU out of operation as described in the operations instructions of the AHU and secure the AHU against inadvertent power-up.



CAUTION!

The electronic components inside the control unit are very sensitive to electrostatic discharge.

Prevention: Before carrying out any maintenance work to the electrical or electronic equipment of the control unit, appropriate measures must be taken to protect the respective components against damage caused by electrostatic discharge (ESD protection).



DANGER!
Health risk by inadequate maintenance!

Inadequately operated and/or poorly maintained adiabatic humidification systems may endanger the health. When inadequately operated and/or poorly maintained micro-organisms (including the bacterium which causes Legionnaire's disease) may grow in the water system and in the area of the humidification unit and may affect the air in the AHU/air duct.

Prevention: the adiabatic humidification system Condair DL must correctly be operated as described in [chapter 4](#), and must be correctly maintained and cleaned in the prescribed intervals as described in [chapter 6](#).

6.2 Hygiene and Maintenance according to VDI 6022 Page 1

The adiabatic air humidification system Condair DL incorporates the very latest technology, and has been designed to guarantee **hygienically trouble-free operation** when **operating conditions are observed**. The hygiene during operation was tested, proven and confirmed by the award of the **SGS-Fresenius Hygiene Certificate** following long-term tests at the Fresenius Institute.

To ensure operational safety and to guarantee hygiene in long-term operation, the **maintenance concept for the Condair DL** has been structured in **two stages**. This differentiates between **periodical checking** and the implementation of a **total system service** of the Condair DL. In order to operate the system according to the regulations "optimised air humidification DGUV" the maintenance must be carried out in accordance with the information given in chapter [chapter 6](#), additionally a maintenance record must be provided.

Hygiene Service

For carrying out a total system service your Condair representative offers maintenance contracts. The trained Condair service technicians have the necessary equipment and carry out the hygiene service upon the newest state of the art. The valid technical guidelines are thereby considered. **For this purpose please contact your Condair representative.**

6.2.1 Periodical checking

Periodical checking should be carried out **monthly** and include the following work:

Item	Work to be carried out
Nozzle system	<ul style="list-style-type: none"> – Check the spray pattern of the atomizing nozzles during operation (spray cone: 60° acceptable). Remove atomizing nozzles with uneven spray pattern and clean them (see total system service). – Check hoses and connections for sealing, if necessary, replace defective components.
Post-evaporation unit	<ul style="list-style-type: none"> – Check ceramic plates for breakage. Damaged plates should be replaced (see full servicing guide). Note: A grey discolouration of the ceramic plates is normal. This is due to deposits from the silver ionisation.
Central unit	<ul style="list-style-type: none"> – Silver ionisation: see detailed information in chapter 6.5. – Check hoses, connections, pressure sensors (PS4 and PS5), valves, etc. in the central unit. Replace defective components where necessary. Important: replace pressure sensors (PS4 and PS5) every 3 years.
Humidifier housing/ Water tub	<ul style="list-style-type: none"> – Check the water container and humidifier housing for soiling (Rust, slime, dust), clean if necessary (see total system service). – Check the water tub behind the post evaporation unit for collection of residual water. If residual water is present, check the water drain and the post evaporation unit.

6.2.2 Total system service

The frequency of the implementation of a total system service depends on the operating conditions. The state of the humidifier's hygiene and its components mostly depends on the quality of the humidifier water, the performance (and the frequency of replacement) of the filter installed before the unit, the air velocity, the air temperature, and the microbiological and chemical composition of the inlet air.



The basic rule is: when the "Service" message appears, or at least once a year, the implementation of a total system service is obligatory.

Resetting the "Service" message

Upon completion of the total system service the **maintenance due message** can be reset via the Service menu (see [chapter 6.7](#)).

Item	Work to be carried out
Nozzle system	<ul style="list-style-type: none"> – Check the spray pattern of the atomizing nozzles during operation (spray cone: 60° acceptable). Remove spray nozzles with a poor spray pattern and clean them in an ultrasonic bath or with a household decalcifier. – Check hoses and connections for sealing, if necessary, replace defective components. – Check spray nozzles for secure seating. Slightly tighten loose nozzles by hand. – Clean supporting structure, nozzle grid(s) and tubing with a combined detergent and disinfectant (application in accordance with manufacturer data), finally rinse all components with hygienically pure water (RO water).
Post-evaporation unit	<ul style="list-style-type: none"> – If the the post-evaporation unit is not accessible for cleaning from the air outlet side, the ceramic plates must be removed. – Check ceramic plates for breakage. Damaged plates must be replaced. – Check ceramic plates for soiling. Dust deposits are to be rinsed off with water. Ceramic plates, which cannot be cleaned any more, have to be replaced. Note: A grey discolouration of the ceramic plates is normal. This is due to deposits from the silver ionisation. If the ceramic plates show severe deposits of dust, the ventilation system air filter should be checked for cracks, cleanliness and filter quality (min. F7 or EU7). Clean soiled plates. – Clean supporting structure and sealing plates with a combined detergent and disinfectant (application in accordance with manufacturer data), finally rinse all components with hygienically pure water (RO water). – Check the supporting structure, the ceramic plates, the sealing plates for correct assembly and tight seating of screw connections. If necessary, install faulty components correctly and tighten loose screw connections.
Central unit	<ul style="list-style-type: none"> – Silver ionisation: observe notes in chapter 6.5 . – Clean filter housing of the optional sterile filter and replace filter cartridge. – Check hoses, connections, pressure sensors (PS4 and PS5), valves, etc. in the central unit. Replace defective components where necessary. Important: replace pressure sensors (PS4 and PS5) every 3 years.

Item	Work to be carried out
Humidifier housing/ Water tub	<ul style="list-style-type: none"> <li data-bbox="550 197 1441 353">– Check the water tub behind the post evaporation unit for collection of residual water. In the event of a substantial amount of residual water, check the water drain and post evaporation unit. Please note: drops of water and small pools of water in the water tray behind the post-evaporation unit are as a rule caused by the system. <li data-bbox="550 353 1441 450">– Clean the water tub and humidifier housing (also clean behind the post evaporation unit) with a combined detergent and disinfectant. Finally rinse all components with hygienically pure water (RO water) and rub dry.
Components installed upstream in the water supply line	<ul style="list-style-type: none"> <li data-bbox="550 456 1441 555">– To ensure hygiene the components installed upstream in the water supply line (e.g. water filter, reverse-osmosis system, etc.) must be cleaned and maintained in accordance with the information of the manufacturer. Important: The water filter in the water supply line (if applicable) must be replaced at least once a year. The water filter must be replaced immediately if the water supply has been contaminated by a malfunction.
Electrical installation	<ul style="list-style-type: none"> <li data-bbox="550 663 1441 757">– Arrange for a qualified specialist to inspect connections and cables, fasten connecting terminals if required. Defective installations must be rectify only by a qualified specialist.
Humidifier water	<ul style="list-style-type: none"> <li data-bbox="550 763 1441 1016">– Determine the bacterial count at the water connection to the central unit. In the event of bacterial count concentrations above the limit of 100 cfu/ml, the water supply/water pipes must be subject to a microbiological inspection and appropriate action must be taken immediately (please contact your Condair representative). Bacterial count concentrations in the upper area of the permitted range may be an indication of the onset of bacterial problems in the water supply. The water supply and water pipes should also be subject to a microbiological inspection.
System air	<ul style="list-style-type: none"> <li data-bbox="550 1023 1441 1272">– Determine the bacterial count in the supply air before the humidifier inlet. In the event of bacterial count concentrations above the limit of 1000 cfu/m³, the ventilation system must be subject to a microbiological inspection and appropriate action must be taken immediately to rectify the situation (please contact your Condair representative). Bacterial count concentrations in the upper area of the permitted range may be an indication of the onset of bacterial problems in the ventilation system. The ventilation system should also be subject to a microbiological inspection. <li data-bbox="550 1272 1441 1332">– Determine the bacterial count in the air at the humidifier outlet to confirm the hygienic function of the humidifier.

6.3 Notes on cleaning and cleaning agents

For the cleaning of the individual system components of the Condair DL use a household cleaning and disinfection agent.

It is mandatory to observe and comply with the manufacturer's information and instructions of the cleaning agents used. Observe in particular: all information relating to the protection of personnel, environmental protection and restrictions regarding usage.



CAUTION!

Do not use any **solvents, aromatic hydrocarbons or halogenised hydrocarbons or other aggressive substances** as they may cause damage to the components of the unit.



DANGER!

Do not use no cleaning agents, which leave poisonous residues. These can get in contact with the ambient air during operation and endanger the health of persons. In any case the components have to be thoroughly rinsed with RO water after cleaning.

6.4 Removal and installation of components

6.4.1 Removal and installation of the ceramic plates

Removal of the ceramic plates

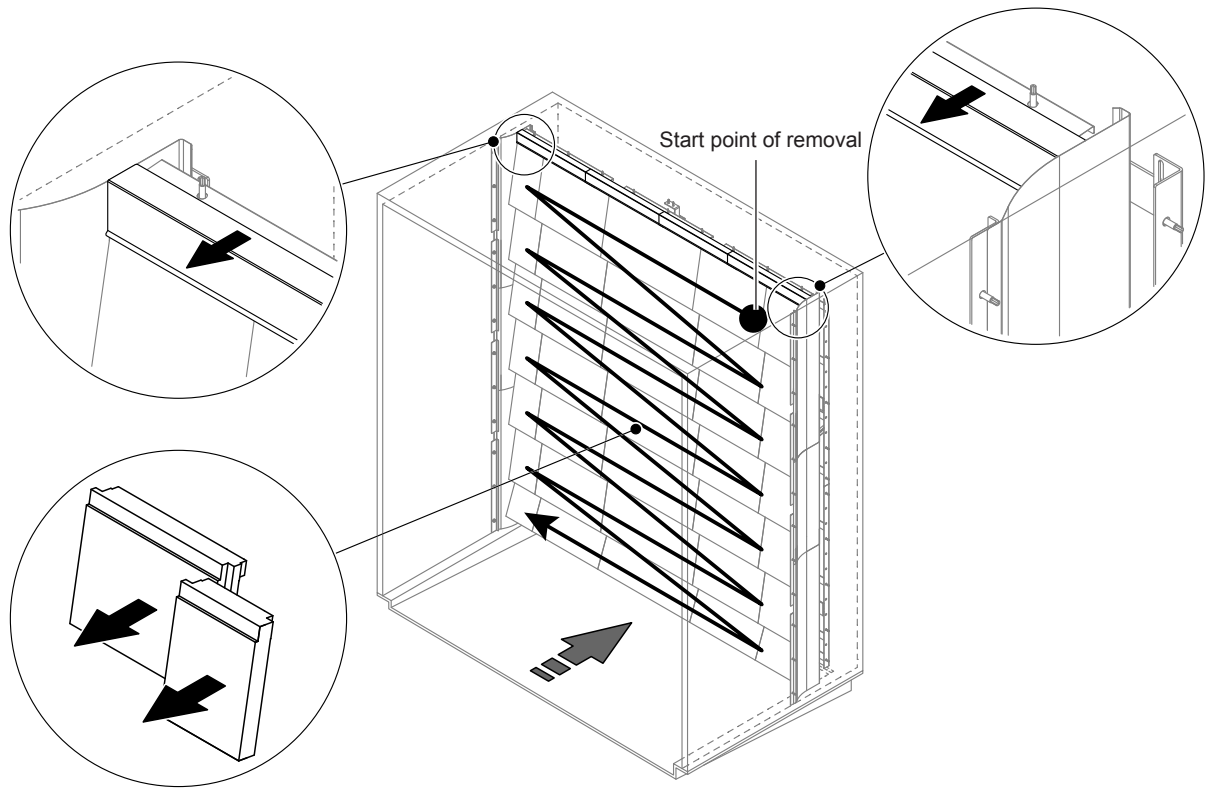

Fig. 9: Removal of the ceramic plates

Proceed as follows to remove the ceramic plates:

1. Remove upper sealing plates.
2. Start on top right and remove the ceramic plates from right to left.
Important: mark position of the ceramic plates for correct re-assembly.
3. Repeat step 2 for all ceramic plate rows.

Installation of the ceramic plates

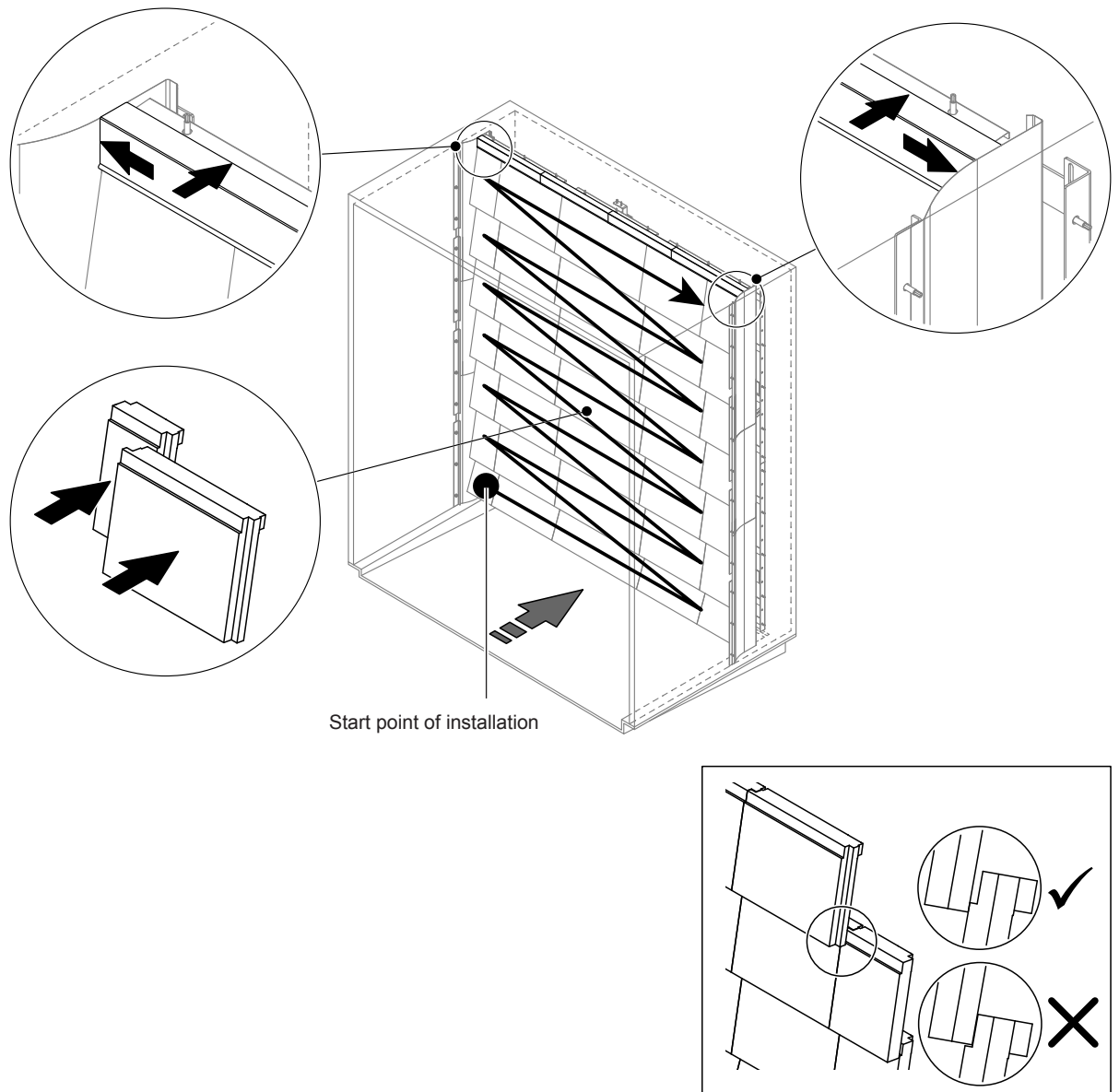

Fig. 10: Installation of the ceramic plates

Before installation, check all ceramic plates for possible damage. Damaged ceramic plates and ceramic angles **must not be reinstalled**.

For installation of the ceramic plates proceed in the reverse order of removal (also see section "Install ceramic plates" in the installation manual).

Important! Make sure to reinstall the ceramic plates in the appropriate locations and that the upper sealing plates on left and the right side are flush with the corresponding the lateral sealing plate.

6.4.2 Removal and installation of the spray nozzles

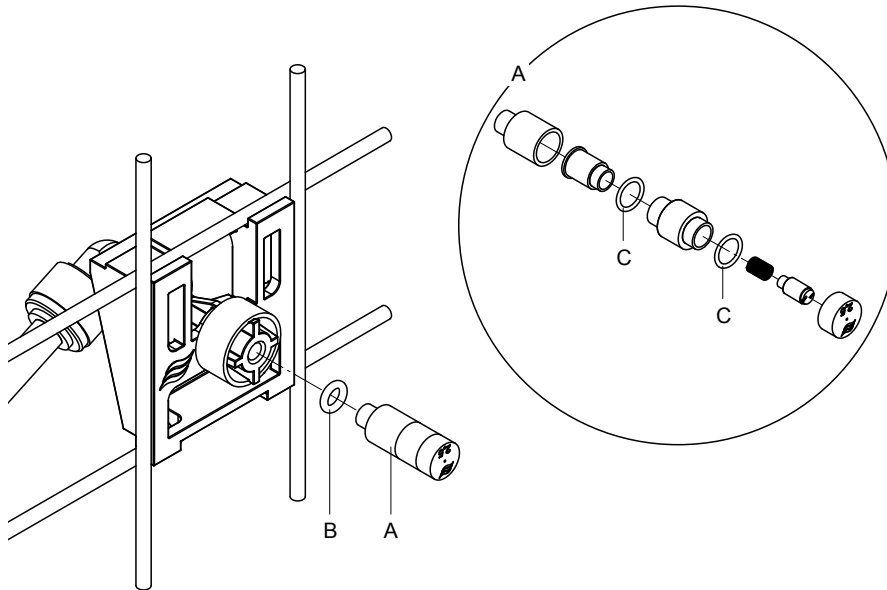

Fig. 11: Removal and installation of the spray nozzles

Removal of the spray nozzles

1. Loosen nozzle "A" by hand and remove it together with the O-ring "B".
Note: prior to the removal note the position and the colour identification of the nozzle.
2. If necessary, disassemble the nozzle according to the illustration above.

Installation of the spray nozzles

1. Before installation, check nozzle "A" and o-rings "B" and "C" for any damage. **Damaged nozzles or damaged o-rings must be replaced.**
2. If necessary, assemble the nozzle according to the illustration above.
3. Before installation of the nozzle flush the corresponding spray circuit by activating the appropriate spray valve via the "Output Diagnostics" submenu.
4. Screw in cleaned or new nozzle with O-ring into the nozzle support and tighten it by hand until it comes to a stop (do not use tools).
Note: make sure the nozzle is installed in the nozzle grid on the right place and with the correct orientation.

6.4.3 Removal and installation of the nozzle support

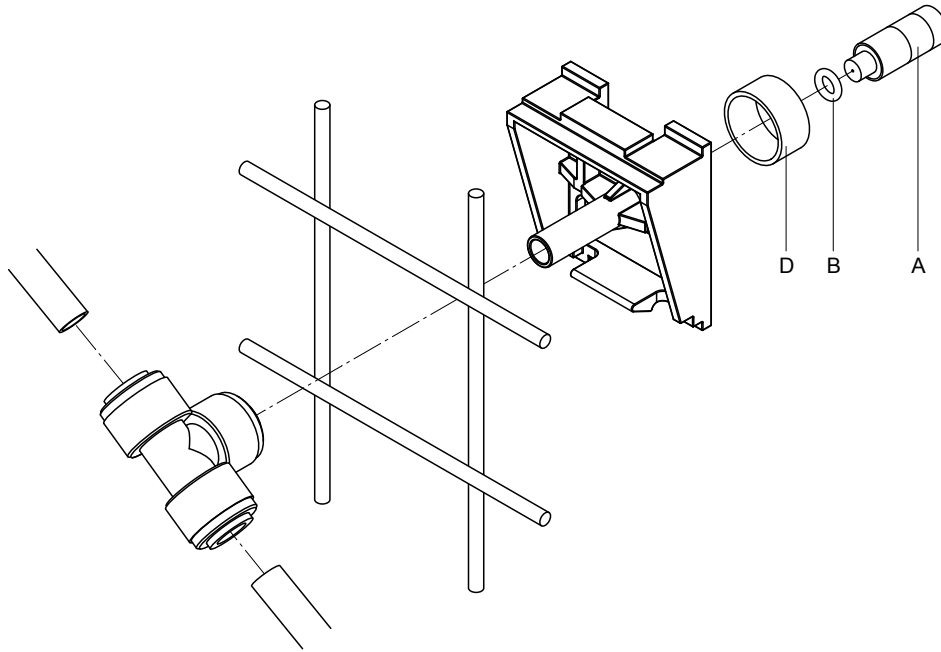

Fig. 12: Removal and installation of the nozzle support

Removal of the nozzle support

1. Remove nozzle "A" together with the O-ring "B" as described in [chapter 6.4.2](#).
2. Remove coloured ring "D" from the nozzle support.
3. Remove the hose(s) from the nozzle support (press the locking ring towards screw, then pull hose off).
4. Remove connection nipple (press the locking ring towards screw, then pull off nipple).
5. Squeeze the catch locks of the nozzle support and remove the support.
Note: prior to the removal note the orientation of the nozzle support (straight, to the left, etc.).

Installation of the nozzle support

1. Before installation, check all parts (including O-rings) for any damage. **Damaged parts must be replaced.**
Important! Before installation, flush water conduits with RO water.
2. The installation follows the reverse order of the removal.
 - Make sure the nozzle support is installed in the nozzle grid on the right place and with the correct orientation.
 - Following installation verify correct fastening of all hose connectors. Correctly mounted hoses can not be removed without pressing the locking ring.

6.5 Replacement of the silver ionisation cartridge "Hygienepius"

If the silver ionisation cartridge is exhausted and needs to be replaced "Error 55 - Ag-Ion Service" is shown. Via the "Service" and "Error" relays on the remote operation and fault indication board, additionally maintenance request is issued.

If the silver ionisation cartridge is not replaced and the Ag maintenance counter is **not reset within 7 days** an error message is triggered and **the humidification is stopped**. Via the "Error" relay on the remote operation and fault indication board, additionally a fault is issued.

Replacing the silver ionisation cartridge

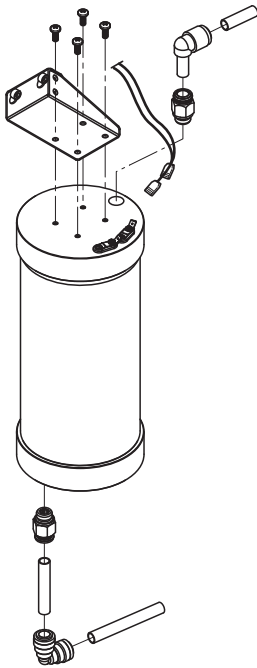

1. Set the adiabatic air humidification system Condair DL **out of operation** as described in [chapter 4.5](#), and **release the pressure in the water system**.
2. Remove the two electrical connectors from the connections on the silver ionisation cartridge.
3. Loosen the hose connectors at the entry and the exit, then remove both screw-in nipples.

CAUTION!

The silver ionization cartridge is filled with water. Place a absorbent rag under the cartridge before loosening the connections and wipe away any splashed water afterwards.

4. Undo the four screws fastening the silver ionisation cartridge to the holder, then remove the cartridge.

CAUTION!

The silver ionisation cartridge weighs approx. 3 kg (6.5 lb)

5. Install the new silver ionisation cartridge in the reverse order.

Important: Exhausted silver ionisation cartridges **must be sent to the local Condair representative for correct disposal**.

6.6 Replacement of the optional sterile filter and de-aeration of the filter housing

Replacing the sterile filter

If error "E66" is shown or before any commissioning for a new humidification season the sterile filter must be replaced.

Important: The sterile filter must be replaced immediately if the water supply has been contaminated due to a malfunction.

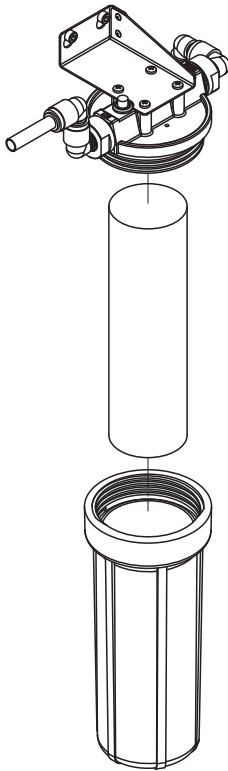

1. Set the adiabatic air humidification system Condair DL **out of operation** as described in [chapter 4.5](#), and **release the pressure in the water system**.
2. Loosen and remove the filter housing. Then, remove filter cartridge.
3. Clean filter housing and upper part of filter.
4. Insert new filter cartridge into the filter housing.
Important! Use original filter cartridge from your Condair representative only.
5. Screw in filter housing with new filter cartridge and tighten it by hand.

De-aeration of the filter housing

After replacement of the sterile filter or when the filter housing has been opened the filter housing must be de-aerated. Proceed as follows:

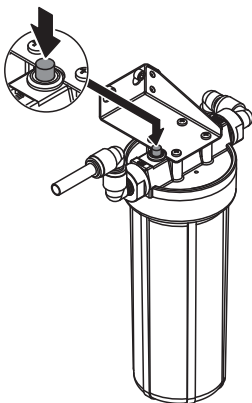

1. Set the adiabatic air humidification system Condair DL into operation as described in [chapter 4.5](#).
Important: a minimum flow pressure of 3.0 bar must present in the water supply line.
2. Perform a manual flushing cycle (see [chapter 4.4.4](#)). As soon as an acoustic noise is audible from the water flow press the red knob on top of the filter housing cover (see illustration) until water (without air) is pouring out.
Note: If an fault message is active the malfunction must be eliminated before a the flushing can be performed.
3. If necessary, stop manual flushing cycle.

6.7 Resetting the maintenance counter

After completing the total system maintenance or after replacement of the Ag ionisation cartridge, the corresponding maintenance indication or maintenance counter, respectively must be reset. Proceed as follows to reset the maintenance counter:

1. Select in the "Service" submenu the corresponding reset function ("System Service Reset" or "Ag Reset").

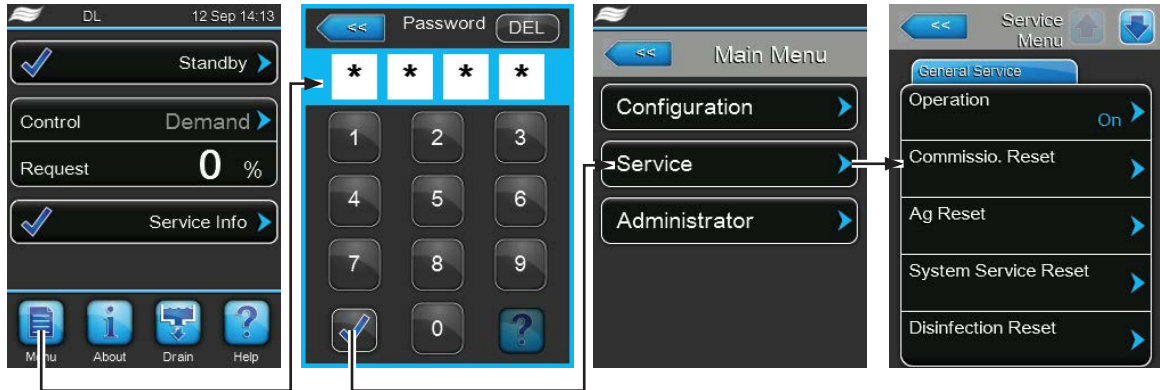

Password: 8808

2. The reset dialogue appears:

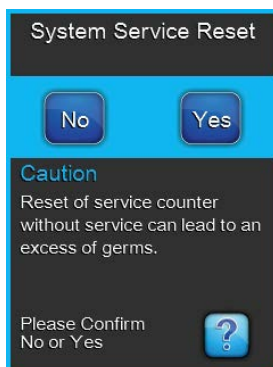

- Press the **<Yes>** button to reset the corresponding maintenance counter ("System Service Reset" or "Ag Reset"). The maintenance counter and the maintenance indication are reset and the control unit is restarted.
- Press the **<No>** button if the maintenance work has not been completed and you want abort the reset procedure. The control unit returns to the "Service" submenu.

6.8 Performing software updates

To update the control software of the Condair DL or the firmware of one of its electronic boards, proceed as follows:

1. Set the **<Control unit On/Off>** switch on the right side of the control unit to the Off position, then switch off the voltage supply to the control unit via the external electrical isolator and secure switch in the Off position to prevent it from inadvertent power up.
2. Unlock the front door of the control unit and remove it.
3. Open control unit inner door.
4. Carefully insert FAT32 formatted USB memory stick containing the software updates into the USB port on the control board. Make sure that the maximum length of the memory stick does not exceed 75 mm (3").

Note: in order to update the control software or the firmware of an electronic board a USB stick with a valid software update (the update files must be on the highest level outside of any folder) must be connected to the USB port on the control board. Otherwise, an appropriate fault message appears when starting the software update.

5. Close control unit inner door, then relocate the front door of the control unit and lock it with the screw.
6. Remove the lock and tag from the external electrical isolator. Then, switch on external electrical isolator to restore power to the control unit.
7. Set the **<Control unit On/Off>** switch on the right side of the control unit to the On position.
8. When the standard operating display appears, select the **<Menu>** button, then enter the password (8808) to login.
9. Select "Administrator > Software Update Tab", then select the desired update function:
 - select "**Software Update**" to update the control software,
 - select "**Driver Board A Update**" update the firmware of the driver board,
 - select "**Driver Condu. Update**" update the firmware of the conductivity board,
 - select "**Driver Aglon Update**" update the firmware of the Ag ionization board.

The update starts. A progress bar is shown in the display. If the update has completed the control unit returns to the standard operating display.



CAUTION!

Do not interrupt a software or firmware update once it has started. Wait until updating is completed. Corrupted control software or firmware can render the control unit unusable.

Note: If software/firmware update is accidentally interrupted, the control unit will not operate, but the software/firmware update can be resumed by leaving the USB key inserted in the control board and power cycling the control unit. The integrated controller will detect the software/firmware was not properly installed, and restart the update.

10. Repeat steps 1 to 3, then carefully remove the USB memory stick.
11. Close control unit inner door, then relocate the front door of the control unit and lock it with the screw.
12. Repeat Step 6 and 7 to power up the control unit.

7 Fault elimination

7.1 Important notes on fault elimination

Qualification of personnel

Repair work must be carried out only by **qualified and well trained professionals authorised by the owner**.

Repair work relating to the electrical installation must be carried out by an electrician or professionals authorised by the owner.

General notes

Repair work on the frequency converter and the booster pump must be carried only by your Condair representative.

Only use original spare parts from your Condair representative to replace defective parts.

Safety



DANGER!
Risk of electric shock!

The control unit of the Condair DL and the pump inside the central unit (if applicable) are mains powered. Live parts may be exposed when the control unit and/or the central unit is/are open. Touching live parts may cause severe injury or danger to life.

Prevention: Before carrying out any work on the components of the Condair DL take the system out of operation as described in [chapter 4.5](#) and secure the system against inadvertent power-up.

Important: the frequency converter in the control unit of Type A systems with booster pump contains condensers, which under certain circumstances may remain loaded with a potentially deadly voltage for a certain amount of time, after the control unit has been separated from the mains. If work has to be carried out on the frequency converter and/or the booster pump wait at least 10 minutes after the control unit has been separated from the mains and make sure the appropriate contacts on the frequency converter and the terminals on the booster pump are free of voltage before starting any work on these components.



CAUTION!

The electronic components inside the control unit are very sensitive to electrostatic discharge.

Prevention: Before carrying out any repair work to the electrical or electronic equipment of the control unit, appropriate measures must be taken to protect the respective components against damage caused by electrostatic discharge (ESD protection).

7.2 Fault indication

Malfunctions during operation detected by the control software are indicated by a corresponding **Warning** message (operation still possible) or **Fault** message (operation not longer possible) in the maintenance and fault indication field in the standard display of the control unit.

Warning



Temporary problems (e.g. water supply interrupted for a short time) or malfunctions which cannot cause damage to the system are indicated with a warning message. **If the cause of the malfunction disappears of its own accord within a certain period of time, the alarm message will automatically switch off otherwise an fault message is triggered.**

Note: warnings can be indicated also via the service relay of the remote operating and fault indication. Therefore the warning indication via the service relay must be activated in the communication menu of the control software (see [chapter 5.4.5](#)).

Fault



Malfunctions where further operation is not possible any longer or malfunctions which can damage the system are indicated with a fault message, additionally the red LED below the touch panel light up. If such a malfunction occurs the operation of the system is limited only or the system will be switched off automatically.

By pressing on the maintenance and malfunction indication field in the standard operating display the error list shown with all active warning and fault messages. By pressing on the corresponding Warning or Fault entry additional information regarding the malfunction are displayed (see display on the far-right).

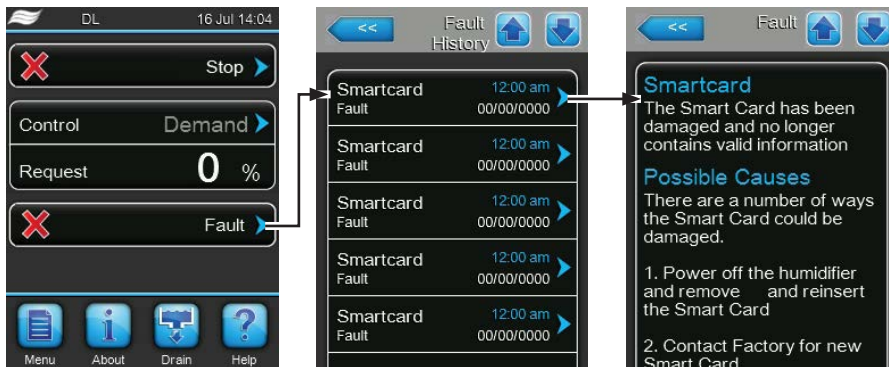

7.3 Malfunction list

Most operational malfunctions are not caused by faulty equipment but rather by improper installation or disregarding of planning guidelines. Therefore, a complete fault diagnosis always involves a thorough examination of the entire system (e.g. hose connections, humidity control system, etc.).

Code		Message	Information	
Warning	Fault		Possible causes	Remedy
W01	E01	Smart Card	No communication with Smart card.	
			No Smart card installed.	Contact your Condair representative
			Smart card not valid or defective.	Contact your Condair representative.
W06	—	UO missing	No communication between Condair DL and reverse osmosis system.	
			Connecting cable between Condair DL control unit and reverse osmosis control unit not connected or interrupted.	Check/connect connecting cable.
			Reverse osmosis system not switched on.	Switch on reverse osmosis system.
—	E10	CTRL Reset	The control unit (Integrated Controller) has been automatically restarted due to a software problem.	
			The control unit (Integrated Controller) has been automatically restarted due to a software problem	Contact your Condair representative if this problem regularly occurs.
W19	E19	Antifreeze	Temperature of the supply water is near the freezing point. Temperature flushing has triggered. Note: The temperature flushing shall prevent the freezing of the hydraulic system by the movement of the water. Humidification is still possible.	
			Temperature of the supply water too low.	Check water system. Insulate water pipes.
			Ambient temperature in the area of the central unit too low.	Place the central unit differently or protect it from the cold.
W20	E20	Safety Loop	External safety loop is open, humidification is stopped! Note: as soon as the safety loop is closed again the humidification system Condair DL continues to work normally.	
			Ventilation interlock open.	Check/switch on fan of the AHU.
			Air proving switch has triggered.	Check fan/filter of the AHU.
			High limit humidistat has triggered.	Wait, check/replace high limit humidistat.
			Fuse "F2" on the driver board defective.	Replace fuse "F2" on the driver board.
W22	E22	Water Missing!	Water inlet pressure too low or not present! Note: as soon as the water pressure rises again above the set minimum value the humidification system Condair DL to work normally.	
			Shut-off valve in the water supply line closed.	Open shut-off valve.
			Reverse osmosis system is regenerating or switched off.	Wait or switch on reverse osmosis system.
			Inlet valve Y1 defective or clogged.	Check/replace inlet valve Y1.
			Pressure sensor PS4 defective.	Replace pressure sensor PS4.
—	E24	Pump Current	Current of booster pump not within valid range, humidification is stopped!	
			Nozzles clogged or defective.	Clean/replace nozzles.
			Wrong nozzle type installed.	Install correct nozzle type.
			Spray valves blocked in closed position.	Check/replace spray valves.
			Frequency converter wrong configured.	Contact your Condair representative.
			Pressure relief valve on booster pump set too high.	Contact your Condair representative.

Code		Message	Information	
Warning	Fault		Possible causes	Remedy
W28	E28	Service	The maintenance interval of the system service has elapsed. If the system service is not performed and the maintenance message is not reset within one week after the maintenance message has been triggered a fault message is triggered!	
			System service due.	Perform system service and reset maintenance counter.
—	E32	Demand Snsr	Demand signal invalid, humidification is stopped!	
			Humidity sensor or external controller not or not correctly connected.	Check/correctly connect humidity sensor/external controller.
			Sensor/controller wrong configured.	Correctly configure sensor/controller via the configuration menu.
			Sensor/controller defective.	Replace sensor/controller.
W35	—	BMS Timeout	BMS (Modbus, BACnet, LonWorks) has stopped sending humidity/demand updates.	
			Signal cable from BMS not connected correctly or defective.	Correctly connect or replace signal cable.
			Interfering signal present.	Eliminate source of interfering signal.
			Address conflict with other units in the network.	Correctly set unit addresses.
W44	E44	Water Temp. Limit	Temperature of the supply water from the reverse osmosis system has exceeded the limit value. Humidification is still possible for the moment	
			Temperature of the supply water too high.	Check water system.
			Ambient temperature in the area of the central unit too high.	Place the central unit differently or ventilate/cool the room.
			Water temperature sensor defective.	Replace water temperature sensor.
			Water temperature sensor not or not correctly connected.	Check/correctly connect the water temperature sensor.
—	E48	Water Temp Snsr	Water temperature signal invalid.	
			Water temperature monitoring activated but water temperature sensor not or not correctly connected.	Retrofit or deactivate water temperature sensor.
			Water temperature sensor defective.	Replace water temperature sensor.
W49	E49	Disinfection	Day counter for the disinfection has expired.	
			Disinfection due.	Perform disinfection and reset the day counter.
W50	—	Out of Commissioning	This message appears on commissioning if the system or the control unit, respectively was disconnected from the mains for more than 48 hours. The system remains blocked for 5 minutes, and then starts automatically with a flushing cycle.	
			The control unit was disconnected from the mains for more than 48 hours.	We recommend to disconnect the water supply line from the reverse osmosis system on the connection of the central unit and to flush the supply line for 5 minutes into a separate drain. Then, reset the "Out of Commissioning" warning as described in chapter 5.5.2 or wait until the message is reset automatically after 5 minutes. Note: after resetting, the control unit must be connected to the mains for at least 15 minutes otherwise the message reappears on the next commissioning.

Code		Message	Information	
Warning	Fault		Possible causes	Remedy
W51	—	Level Disinf.Pump	Level of the disinfectant in the tank is too low. Humidification is further possible for limited period of time!	
			Disinfectant in the tank is used up.	Refill disinfectant.
			Level sensor is not or not correctly connected.	Check/correctly connect level sensor.
			Level sensor defective.	Replace level sensor.
—	E54	Leak Sensor	Leak monitoring has triggered, humidification is stopped!	
			Water supply line and/or spray circuit lines to the duct and/or water drain line leaky.	Check/seal water supply line, spray circuit lines and water drain line.
			Components (tubes, valves, Ag cartridge, etc.) in the central unit leaky.	Check/seal/replace components in the central unit.
			Fuse "F2" on the driver board defective.	Replace fuse "F2" on the driver board.
W55	E55	Ag-Ion Service	Ag cartridge is exhausted and must be replaced, humidification is further possible for limited period of time!	
			Ag cartridge not replaced or Ag maintenance counter not reset after Ag cartridge has been replaced.	Replace Ag cartridge and reset Ag-maintenance counter.
—	E57	Activation	Activation code has not been entered yet.	
			Activation code has not been entered yet.	Enter activation code (code available from your Condair representative).
—	E58	Pr.Sens.Inlet	Invalid signal from inlet water pressure sensor PS4!	
			Pressure sensor PS4 not or not correctly connected.	Check/correctly connect pressure sensor PS4.
			Pressure sensor PS4 wrong configured.	Correctly configure pressure sensor PS4.
			Pressure sensor PS4 defective.	Replace pressure sensor PS4.
—	E59	Sensor NozzPress	Invalid signal from nozzle pressure sensor PS4!	
			Pressure sensor PS5 not or not correctly connected.	Check/correctly connect pressure sensor PS5.
			Pressure sensor PS5 wrong configured.	Correctly configure pressure sensor PS5.
			Pressure sensor PS5 defective.	Replace pressure sensor PS5.
—	E62	Nozzle Pressure	Nozzle pressure too high!	
			Wrong type of nozzle installed.	Install correct type of nozzle.
			Nozzles clogged.	Clean/Replace nozzles.
			Max. nozzle pressure set too high.	Contact your Condair representative.
			Wrong order of spray circuits or spray valves.	Correctly connect spray circuits.
			Pressure relief valve on booster pump set too high.	Contact your Condair representative.
—	E63	Aglon Broken	No sufficient current can be built up in the Ag cartridge!	
			Ag cartridge exhausted or defective.	Replace Ag cartridge.
			Electrical supply to Ag cartridge interrupted.	Correctly connect Ag cartridge.
			Installed Ag cartridge too small.	Install correct Ag cartridge.
			Ag board defective.	Replace Ag board.
—	E64	Aglon Shortcut	Short circuit on Ag cartridge!	
			Ag cartridge has internal short circuit due to material defect or due to exhaustion.	Replace Ag cartridge.

Code		Message	Information	
Warning	Fault		Possible causes	Remedy
—	E65	Aglon Test	Daily Ag Ion test failed.	
			The Ag cartridge can not build up the required maximum current because the end of life-span of the cartridge is reached or a wrong cartridge type is installed.	Replace Ag cartridge.
—	E66	Sterile filter	Pressure after sterile filter too low.	
			Filter clogged.	Disinfect RO water supply line and replace sterile filter.
			Pressure switch PS2 after sterile filter defective.	Check/replace pressure switch PS2.
			Pressure sensor PS5 defective.	Check/replace pressure sensor PS5.
W67	E67	No pressure	Air pressure of the compressed-air flushing option too low or no pressure present.	
			Pressure regulator wrongly adjusted.	Correctly adjust pressure regulator (4...5 bar).
			Shut-off valve in the compressed-air supply line closed.	Open shut-off valve in the compressed-air supply line.
			Air cleaning valve Y3 clogged or defective.	Check/replace air cleaning valve Y3.
—	E70	Conduct. Sensor	Invalid signal from Conductivity sensor!	
			Conductivity sensor disconnected or connecting cable interrupted.	Correctly connect conductivity sensor.
			Conductivity monitoring wrong configured.	Correctly configure conductivity monitoring.
			Conductivity board defective	Replace conductivity board.
W71	E71	Limite Permeate	Conductivity of the supply water from the reverse osmosis system has exceeded the lower limit value! Humidification still possible at the moment.	
			Reverse osmosis system defective or wrong configured or service due.	Check/repair reverse osmosis system.
			Conductivity sensor not correctly set.	Contact your Condair representative.
—	E72	Condu Permeate	Conductivity of the supply water from the reverse osmosis system has exceeded the upper limit value! Humidification is stopped!	
			Reverse osmosis system wrong configured.	Correctly setup reverse osmosis system.
			Permeate membrane of the reverse osmosis system defective or service due.	Check/repair reverse osmosis system.
			Conductivity board wrong configured or defective.	Contact your Condair representative.
			Conductivity sensor soiled or defective (short circuit).	Replace conductivity sensor.
—	E74	Keep Alive	Communication between control board and driver board interrupted.	
			Driver board not connected.	Correctly connect driver board.
			Wrong driver board installed.	Install and connect correct driver board.
			Driver board defective.	Replace driver board.
	E80	USB Logger	USB data logger fault.	
			USB data logger not connected or defective.	Check/replace USB data logger.
W82	E82	Driver Missing	Communication with driver board interrupted.	
			RS485 Bus to driver board interrupted.	Contact your Condair representative.
—	E84	Driver defective	Unknown fault on driver board	
			Driver board defective.	Replace driver board.

Code		Message	Information	
Warning	Fault		Possible causes	Remedy
—	E85	Driver ID wrong	Driver board ID wrong.	Contact your Condair representative.
			Wrong driver board connected or SAB address wrong.	
—	E86	Driver Incompatible	Wrong version of driver board.	Contact your Condair representative.
			Wrong version of driver board.	
—	E87	Local 24V Supply	Local 24V voltage on driver board out of valid range!	Contact your Condair representative.
			Short circuit on supply module or supply module defective.	
—	E88	Local 5V Supply	Local 5V voltage on driver board out of valid range!	Contact your Condair representative.
			Short circuit on supply module or supply module defective.	
—	E89	Local Ref Supply	Local reference voltage out of valid range!	Contact your Condair representative.
			DC supply faulty or supply line interrupted.	
—	E91	Pressure Instable	Water inlet pressure instable!	Check/completely open shut-off valve. Check reverse osmosis system. Install water supply line with lager cross section (min. ø10/12 mm). Clean sterile filter housing and replace filter cartridge.
			Shut-off valve in the water supply line not fully open.	
			Pressure of the reverse osmosis system too low.	
			Cross section of the supply line too small.	
—	E93	FC Error	Monitoring of the frequency converter has triggered.	Contact your Condair representative. Replace fuse "F1" on the driver board. Contact your Condair representative.
			Frequency converter overloaded, too hot or over current monitoring has triggered. Error code can be checked on frequency converter.	
			Fuse "F1" on the driver board defective.	
			Pressure relief valve on booster pump set too high.	
—	E94	FC Current	Current of the frequency converter is too high!	Replace booster pump or pump motor. Check settings and correctly configure if necessary. Spray circuit valves check/replace. Check/clean/replace Nozzles or spray circuit lines. Contact your Condair representative.
			Booster pump or pump motor blocked.	
			Frequency converter or control wrong configured.	
			Spray circuit valves clogged or defective.	
			Nozzles or spray circuit lines clogged.	
			Pressure relief valve on booster pump set too high.	
—	E96	Per. 5V Supply	Peripheral 5V supply out of valid range.	Check wiring. Replace fuse "F2" on the driver board. Disconnect load on terminal X16. Replace pressure sensor.
			5V supply interrupted.	
			Fuse "F2" on the driver board defective.	
			Overload on external connection.	
			Overload due to defective pressure sensor.	
—	E97	Ext. 24V Supply	External 24 V supply faulty. Voltage too high or too low.	Replace fuse "F2" on the driver board. Remedy short circuit. Disconnect load on terminal X16.
			Fuse "F2" on the driver board defective.	
			Short circuit on external connection.	
			Overload on external connection.	

Code		Message	Information	
Warning	Fault		Possible causes	Remedy
—	E98	Ext. 10V Supply	External 10 V supply faulty. Voltage too high or too low.	
			Fuse "F2" on the driver board defective.	Replace fuse "F2" on the driver board.
			Short circuit on external connection.	Remedy short circuit.
			Overload on external connection.	Disconnect load on terminal X16.
—	E100 to E107	DO Yx (e.g. DO Y5)	Fault on corresponding spray valve (Y5 to Y9).	
			Spray valve not connected or coil defective.	Correctly connect spray valve or replace coil.
—	E110	DO Y10	Fault on drain valve Y10.	
			Drain valve not connected or coil defective	Correctly connect drain valve or replace coil.
—	E111	Y4	Fault on external optional water supply flushing valve Y4.	
			Water supply flushing valve not connected or coil defective	Correctly connect water supply flushing valve or replace coil.
—	E113	Y3	Fault on optional air cleaing valve Y3.	
			Air cleaing valve not connected or coil defective	Correctly connect air cleaing valve or replace coil.
—	E118	Water Temp.	Temperature of the supply water form the reverse osmosis system has exceeded the limit value. Humidification is stopped.	
			Ambient temperature in the area of the central unit too high.	Place the central unit differently or ventilate/cool the room.
			Supply water temperature too high.	Check water system.
			Water temperature sensor defective.	Replace water temperature sensor.
			Water temperature sensor not or not correctly connected.	Check/correctly connect the water temperature sensor.
—	E153	Y11	Fault on optional auxiliary outlet valve Y11.	
			Auxiliary outlet valve not connected or coil defective.	Correctly connect valve or replace coil.

7.4 Malfunctions without indication

The following table presents failures that do not trigger an fault message, together with indications on their cause and notes on how to eliminate the sources of trouble

Failure	Cause	Remedy
Residual water in the section of the duct outside the water tub.	Sealing elements improperly installed or defective	Mount sealing elements correctly or replace, as required
	Ceramic plates improperly installed or ceramic plates broken.	Correctly install or replace ceramic plates.
	Air velocity in the duct is too high (systems without booster >2.5 m/s, systems with booster >4 m/s).	Reduce air velocity in the duct, if possible, or install booster (consult your Condair representative beforehand).
Condair DL humidifies permanently.	Nominal value of humidity is set too high.	Set nominal value correctly.
	Ambient humidity very low.	Wait.
	The internal controller is activated although an external controller is connected.	Deactivate the internal controller.
Spray valves open and close continually.	Unstable control signal.	Check controller settings and adjust controller, as required.
Maximum humidification capacity is not reached	Capacity limitation active.	Deactivate capacity limitation (set to: 100%).
	System incorrectly dimensioned (insufficient capacity).	Contact your Condair representative.
	Booster pump defective (insufficient permeate pressure)	Replace booster pump.
	Pressure relief valve of booster pump not adjusted correctly.	Contact your Condair representative.
Booster pump starts too late or not at all	Capacity limitation activated.	Deactivate capacity limitation (set to: 100%).
	Booster pump not activated.	Contact your Condair representative.
	Soft start function in progress.	Wait until set time has elapsed and the soft start function is terminated.
Spray valve Y5 (stage 1) and/or spray valve Y6 (stage 2) and/or spray valve Y7 (stage 3) do not open	Spray valve Y5 and/or spray valve Y6 and/or spray valve Y7 defective.	Replace spray valves.
	Capacity limitation active.	Deactivate capacity limitation (set to: 100%).
Spray valve Y8 and/or Y9 (stage 2) do not open even with 100% humidity demand.	Spray valve Y8 and/or spray valve Y9 defective or not activated in the control system.	Contact your Condair representative.
	Wrong stage control (7-steps instead of 15-steps)	Contact your Condair representative.
The humidifier is automatically powered down after about one week of operation.	Ag ionisation defective or exhausted. Capacity counter run-out.	Replace silver ionisation cartridge and reset the capacity counter.

7.5 Saving fault and service histories to a USB memory stick

The fault and service histories of the Condair DL can be saved to a USB memory stick for logging and further analysis. For this purpose proceed as follows:

1. Set the **<Control unit On/Off>** switch on the right side of the control unit to the Off position, then switch off the voltage supply to the control unit via the external electrical isolator and secure switch in the Off position to prevent it from inadvertent power up.
2. Unlock the front door of the control unit and remove it.
3. Open control unit inner door.
4. Carefully insert FAT32 formatted USB memory stick into the USB port on the control board. Make sure that the maximum length of the memory stick does not exceed 75 mm (3").
5. Close control unit inner door, then relocate the front door of the control unit and lock it with the screw.
6. Remove the lock and tag from the external electrical isolator. Then, switch on external electrical isolator switch to restore power to the control unit.
7. Set the **<Control unit On/Off>** switch on the right side of the control unit to the On position.
8. When the standard operating display appears, select the **<Menu>** button, then enter the password (8808) to login.
9. Select **"Service > Fault/Service History Tab > Export History"**. The last 40 faults and service history events are then downloaded to the memory stick as separate .csv files labelled "WARNING_FAULT.csv" and "SERVICE_HISTORY.csv".
Note: the CSV files can be processed with a spread-sheet program on a PC.
Important! If you want to export fault and service history lists from different Condair humidifiers always rename the files on the USB memory stick before exporting the lists of the same event type from another humidifier. Otherwise lists of the same type of event, already exported, are overwritten without warning on the USB memory stick!
10. Repeat steps 1 to 3, then carefully remove the USB memory stick.
11. Close control unit inner door, then relocate the front door of the control unit and lock it with the screw.
12. Repeat Step 6 and 7 to power up the control unit.

7.6 Resetting the fault indication

To reset the error indication (red LED light, operating status indication shows "Stop"):

1. Disconnect the control unit from the mains via the **<Control unit On/Off>** switch (located on the right side of the control unit).
2. Wait approx. 5 seconds, then reconnect the control unit to the mains by switching the **<Control unit On/Off>** switch again.

Note: If the fault has not been eliminated, the fault indication reappears after a short while.

7.7 Replacing the fuses and backup battery in the control unit

The fuses of the control unit must be replaced by **authorized personnel only** (e.g. electrician).

Replace fuses of the control unit only with fuses matching the specifications below with the appropriate nominal current capacity.

Never use refurbished fuses. Do not bridge the fuse holder.

To replace the fuses or the backup battery proceed as follows:

1. Disconnect control unit from the mains by switching off the electrical isolator and secure electrical isolator in "Off" position against inadvertent switching on.
2. Undo the screw of the front cover of the control unit, then remove the front cover.
3. Open control unit inner door.
4. Replace desired fuse or the backup battery.



DANGER!

The contact protection of fuse "F1" must mandatory be relocated after the fuse has been replaced.

5. Close control unit inner door, then relocate the front door of the control unit and lock it with the screw.
6. Reconnect control to the mains by switching on the electrical isolator.

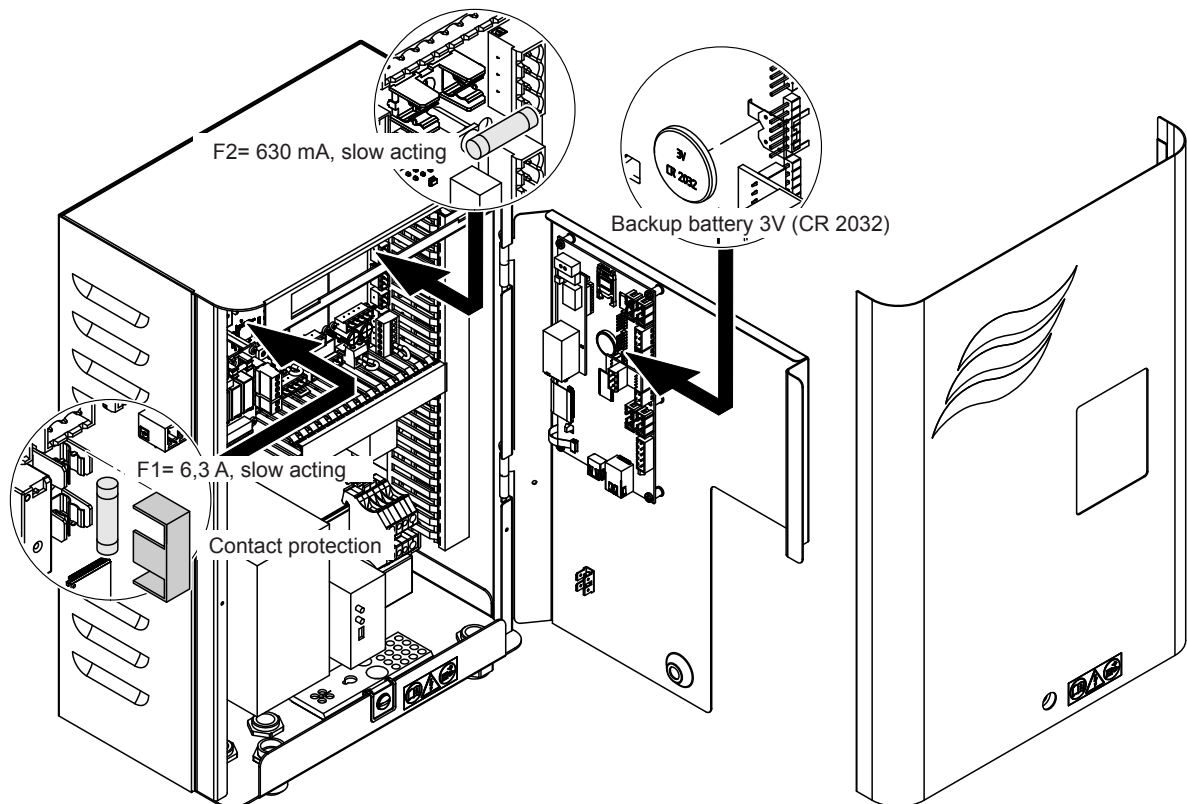

8 Taking out of service/Disposal

8.1 Taking out of service

If the adiabatic air humidification system Condair DL must be replaced or if the humidification system is not needed any more, proceed as follows:

1. Take the adiabatic air humidification system Condair DL out of operation as described in [chapter 4.5](#).
2. Have the system components unmounted by a qualified service technician.

8.2 Disposal/Recycling

Components not used any more must not be disposed of in the domestic waste. Please dispose of the individual components in accordance with local regulations at the authorised collecting point.

If you have any questions, please contact the responsible authority or your local Condair representative.

Thank you for your contribution to environmental protection.

9 Product specification

9.1 Technical data

	Condair DL			
	Type A (with booster pump)		Type B (without booster pump)	
Dimensions/Weight				
Installation length in AHU/duct (Min-Max)	600 - 900 mm ¹⁾			
Width AHU/duct (Min-Max)	450 - 8400 mm ²⁾			
Height AHU/duct (Min-Max)	450 - 4000 mm ²⁾			
Dimensions central unit HxWxD	800 x 500 x 250 mm			
Weight central unit	approx. 54 kg		approx. 35 kg	
Dimensions control unit HxWxD	450 x 315 x 190 mm			
Weight control unit	approx. 14 kg			
Wet weight post-evaporation unit	approx. 55 kg/m ² humidifier area			
Dry weight post-evaporation unit	approx. 40 kg/m ² humidifier area			
Hydraulic				
Humidification capacity	5 ... 1000 l/h ³⁾		5 ... 1000 l/h ³⁾	
Nozzle pressure	3 ... 7 bar			
Nozzle sizes	8 (1.5, 2.0, 2.5, 3.0, 3.5, 4.0, 4.5 and 5.0 l/h at 4 bar)			
Spray circuit valves	3/2 way NO (normally open)			
Flushing water consumption	<210 kg/h nozzle capacity: 2.2 - 2.5 l/min at 4 bar >210 kg/h nozzle capacity: 3.7 - 4.0 l/min at 4 bar			
Electric				
Supply voltage/current control unit	200 ... 240 VAC / 50..60 Hz, max. 6 A		115 ... 240 VAC / 50..60 Hz, max. 6 A	
Control booster pump motor	continuous with frequency converter		—	
Power consumption control unit (including solenoid valves)	55 ... 65 VA (dependent on the number of switched valves and whether the display is in sleep mode or not)			
Motor rating booster pump	approx. 12 VA per 10 kg/h spray capacity		—	
Voltage solenoid valves (Y1-Y10)	24 V DC			
Frequency converter	Yes		No	
Control signals	0-20VDC, 0-10VDC, 0-8.25VDC, 1-5VDC, 0-5VDC, 0-1VDC, 0-20mA, 4-20mA			
Control accuracy ⁴⁾	7-steps: ±3 %rh and 15-steps: ±2 %rh		7-steps: ±4 %rh and 15-steps: ±3 %rh	
Number of steps (humidity control)	Number of steps	Possible humidifier capacity range [kg/h]	min. cross section [m ²]	max. capacity at min. cross section ⁵⁾ [kg/h]
	3	5 - 10	0.2	10
	7	> 10 - 560	0.4	45
	15	> 25 - 1000	1.1	99
	31	> 55 - 1000	1.8	204
Sound level				
Sound level	approx. 51 dB(A)		approx. 41 dB(A)	
Hygiene				
Silver ionisation cartridge "Hygieneplus"	Yes			

	Condair DL	
	Type A (with booster pump)	Type B (without booster pump)
Communication		
Remote operating and fault indication board	Yes	
Modbus RTU	Yes	
BACnet IP and BACnet MSTP Master or Slave Mode	Yes	
Interfaces		
Ethernet	Yes	
USB	Yes	
RS 485	Yes	
Air		
Pressure drop (2 m/s)	approx. 40 Pa	
Max. air velocity	2.5 m/s (without booster), 4 m/s (with booster)	
Air filter quality before humidification unit	F7 (EU7) or better	
Max. recommended air temperature	60°C (before humidification unit) ⁵⁾	
Water		
Connector water supply	ø12 mm plug-in coupling or 1/2" male thread adapter (supplied)	
Connector water drain	ø10 mm plug-in coupling or 1/2" male thread adapter (supplied)	
Admissible water supply pressure	working pressure 3 ... 7 bar	working pressure 3 ... 7 bar
Admissible water temperature	5 ... 20 °C	
Water quality requirements	fully demineralised water from reverse osmosis system with 0.5...15 µS/cm (without any additives), max. 100 cfu/ml	
Operating monitoring RO water	min. pressure, max. pressure, pressure after sterile filter, conductivity	
Ambient conditions operation		
Admissible ambient temperature	5 ... 40 °C	
Admissible ambient humidity	10 ... 80 %rh, non condensing	
Ambient conditions storage		
Admissible ambient temperature	5 ... 40 °C	
Admissible ambient humidity	10 ... 75 %rh, non condensing	
Protection class		
Control unit	IP22	
Central unit	IP22	
Certificates		
Certificates	CE, DGUV, EAC	

¹⁾ Larger installation length on demand

²⁾ Larger dimensions on demand

³⁾ Larger capacities on demand (consider possible number of steps for capacity range!)

Note: For systems "Type A" (with booster pump), the minimum output of 5 kg/h can only be regulated at a flow pressure <4.0 bar. With a flow pressure of ≥4.0 bar, we recommend a minimum output of 10 kg/h for "Type A" systems.

⁴⁾ The nominal control accuracy may not always be available, because various factors (temperature control, water recycling, flap valve systems, etc.) may affect the accuracy.

⁵⁾ These values can be smaller influenced by other limit values such as humidity, volume flow or air speed! The values are to be understood as theoretical approximate values, which are determined by the number of nozzles and their size. The maximum capacity values are achieved only with a booster pump.

9.2 Options

Options	Condair DL	
	Type A (with booster pump)	Type B (without booster pump)
Leak monitoring	x	x
Sterile filter	x	x
Air cleaning	x	x ¹⁾
External pipe flush	x	x
External water filter 5 µm	x	x
Gateway board (LonWorks or BACnet IP/BACnet MSTP)	x	x
Mounting rack for central unit and control unit	x	x
Relais external dosing: Relais contact for the control of an external disinfection pump (optional, pump delivered by others).	x	x
Service disinfection: Connector for the hydraulic system for the introduction of disinfectant.	x	–
Water temperature monitoring: Monitoring of the inlet water temperature for triggering of a flushing if the limit values for the inlet water temperature are exceeded.	x	x
External valve block with additional drain valve: The valve block is integrated in an external housing separately from the central unit.	x	–

¹⁾ available only for Type B with sterile filter

10 Appendix

10.1 CE declaration of conformity



EC

Konformitätserklärung	Declaration of conformity	Déclaration de conformité
Wir, Condair Group AG CH-8808 Pfäffikon SZ erklären in alleiniger Verantwortung, dass das Produkt	We, Condair Group AG CH-8808 Pfäffikon SZ declare under our sole responsibility, that the product	Nous, Condair Group AG CH-8808 Pfäffikon SZ déclarons sous notre seule responsabilité, que le produit
Condair DL A Condair DL B		
auf das sich diese Erklärung bezieht, mit den folgenden Normen oder normativen Dokumenten übereinstimmt	to which this declaration relates is in conformity with the following standards or other normative standards	auquel se réfère cette déclaration est conforme aux normes ou autres documents normatifs
EN 61000-6-2 EN 61000-6-3 EN 60335-1 EN 60355-2-88		
und den Bestimmungen der folgenden Richtlinien entspricht	and is corresponding to the following provisions of directives	et est conforme aux dispositions des directives suivantes
2006 / 42 / EC 2014 / 30 / EU VDI 3803 VDI 6022-1 VDI 6022-2		

2588660 DE/EN/FR 1905

Pfäffikon , May 01, 2019
Condair Group AG

Robert Merki
Head of Engineering

Condair Group AG
Gwattstrasse 17
8808 Pfäffikon SZ, Switzerland
Phone +41 55 416 61 11, Fax +41 55 588 00 07
info@condair.com, www.condair-group.com

Notes

CONSULTING, SALES AND SERVICE:



CH94/0002.00

Condair Group AG
Gwattstrasse 17, 8808 Pfäffikon SZ, Switzerland
Phone +41 55 416 61 11, Fax +41 55 588 00 07
info@condair.com, www.condair-group.com

The Condair logo, consisting of a stylized wave symbol to the left of the word 'condair' in a bold, lowercase, sans-serif font.